

# Landing a Helicopter on a Moving Target

Srikanth Saripalli and Gaurav S. Sukhatme

**Abstract**—We present the design of an optimal trajectory controller for landing a helicopter on a moving target. The trajectory planner is based on the Variational Hamiltonian and Euler-Lagrange equations. We use a kinematic model of the helicopter to derive an optimal controller that is able to track an arbitrarily moving target and then land on it. Simulations are shown to verify the performance of the optimal trajectory controller. Data from real flight trials is presented to validate the inputs obtained from the trajectory planner to track a desired trajectory. We present initial trials in simulation for landing the helicopter autonomously on a moving target.

## I. INTRODUCTION

Unmanned aerial vehicles, particularly ones with vertical takeoff and landing capabilities (VTOL), have received considerable attention in the past decade [1–4]. Helicopters are highly maneuverable vehicles that can perform agile maneuvers, as well as hover in place. They can take-off and land from moving platforms such as a shipdeck. Autonomous helicopters equipped with the ability to land on moving targets would be very useful for various tasks such as search and rescue, law enforcement and military scenarios where micro air vehicles (MAVs) may want to land on a convoy of enemy trucks.

We have previously developed a system which was successful in landing a helicopter autonomously on a stationary target using vision and global positioning system [5]. In this paper we present the design of a trajectory planning and control algorithm for landing on a moving target.

We decompose the problem of landing on a moving target into four stages. The first stage consists of detecting the target. We use vision for this purpose. We assume the target shape is known and no distractor targets are present. The second stage is tracking the target. We formulate the tracking problem as a Bayesian estimation problem and (under linear system and Gaussian white noise assumptions) solve it using a Kalman filter. The third stage is motion planning which plans a desired landing trajectory for the helicopter to land on the moving target. The fourth and last stage is control, which regulates the location of the helicopter over time, in accordance with the planner output.

The general problem of trajectory planning and control for landing a helicopter on a moving target can be formulated as: Given a mechanical system (state denoted by  $X$ ) and initial and final conditions  $X(t_0) X(t_f) \in \mathfrak{X}$  where  $\mathfrak{X}$  is the state space of the system, we have to find a control signal  $u : t \rightarrow u(t)$  such that at time  $t_f$  the system reaches

Srikanth Saripalli and Gaurav Sukhatme are with the Department of Computer Science at University of Southern California, Los Angeles, CA - 90089, USA. srik|gaurav@robotics.usc.edu

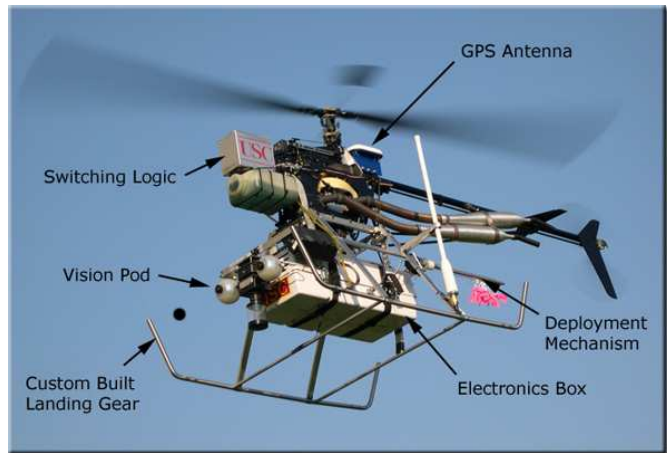

Fig. 1. The Autonomous Vehicle Aerial Tracking and Reconnaissance (AVATAR) [6]

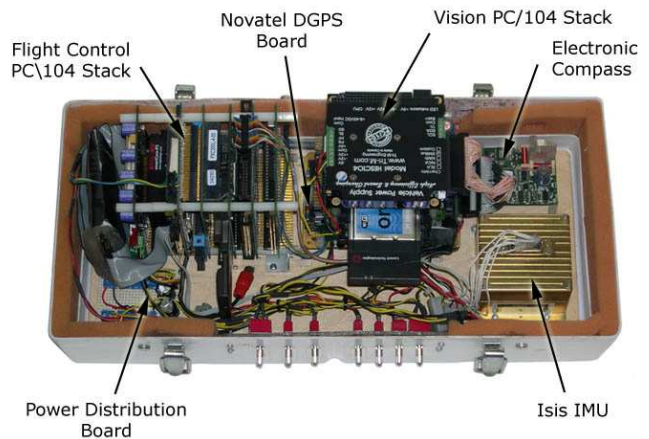

Fig. 2. Avionics Package for the helicopter

$X(t_f)$ . The generalized problem is to find control inputs for a model helicopter for the entire range of a family of trajectories. Although such problems have been considered for general cases [7], to our knowledge, this is the first time that such a formalization is being applied to a combination of tracking a moving target and landing on it using an unmanned helicopter.

The first two stages of the problem - target detection and target tracking have received considerable attention in the vision literature. For a general introduction to vision-based control the reader is referred to [8,9] and for target tracking to [10]. The reader is referred to [11, 12] for algorithms which are used particularly for tracking and landing on a

stationary target using visual inputs from a helicopter. We have previously solved the problem of tracking a moving target with known features using an helicopter in [5]. In the present paper we focus on optimal trajectory planning and control for landing a helicopter on a moving target.

## II. TRAJECTORY CONTROL

We use a reduced model of the helicopter for generating the optimal landing trajectory for landing on a moving target. In the early 1990s, [13] and [14] researched methods of optimal trajectory path planning for trajectory following and terrain masking using a reduced order formulation for a helicopter based on a constant velocity approach. We formulate the problem based on the same approach but do not make any assumptions about the velocity. Also while [15] has used the same formulation for trajectory optimization and rendezvous problems, we use the approach for landing on a moving target.

The problem is formulated using the kinematic equations of the helicopter and an optimal trajectory controller for the helicopter is found using the Hamiltonian and Euler-Lagrangian formulation. This method is capable of rapidly generating optimal solutions and is based on the Pontryagin's minimum principle.



Fig. 3. An typical image obtained from the downward pointing camera on the helicopter during one of the trials. The landing target is the **H** shape.

In general trajectory synthesis via optimal control theory demands the solution of a two-point boundary value problem which is often time-consuming. In the technique described here the optimal route to any final condition can be generated by selecting the initial value of the heading angle and integrating the three first-order differential equations of motion forward in time. The algorithm requires the existence of the first and second order partial derivatives of the trajectory to be followed. This is possible since we use a cubic spline parameterization of the trajectory as discussed below.

### A. Cubic Spline Trajectory

We approximate the desired trajectory to be followed by the helicopter for tracking and landing by a cubic polynomial

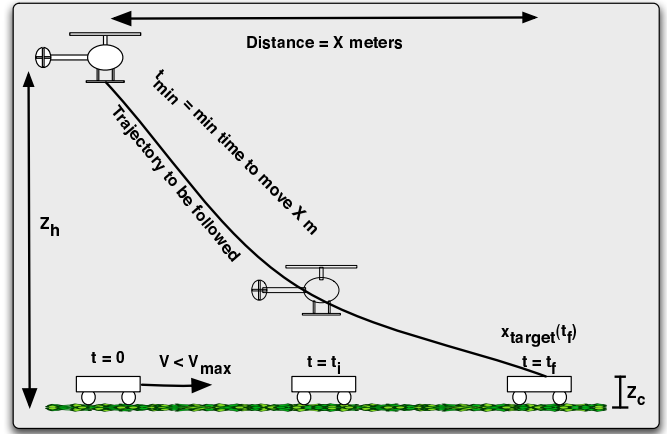

Fig. 4. Schematic for landing on a moving target

where the altitude  $z$  varies with time  $t$  at a given position  $x$  and  $y$  as follows:

$$z(t) = a_0 + a_1 \cdot t + a_2 \cdot t^2 + a_3 \cdot t^3 \quad (1)$$

The following boundary conditions should be satisfied

$$z(0) = z_o \quad z(t_f) = z_c \quad \dot{z}(0) = 0 \quad \dot{z}(t_f) = 0$$

where  $t_f$  is the final time. In the above equations  $z(t)$  represents the height of the helicopter above the ground at time  $t$  (parameterized as a cubic spline).  $z(0)$  represents the height of the helicopter at time  $t = 0$ <sup>1</sup>.  $z(t_f)$  represents the final altitude given by  $z_c$  since the target is at a height  $z_c$  above the ground. Also  $\dot{z}(0)$  and  $\dot{z}(t_f)$  represent the initial and the final velocities in the  $z$  direction and they should be zero. Finally when the helicopter has landed on the target the velocity of the target and the helicopter should be the same. This is represented by  $\dot{x}_h = \dot{x}_{target}$ . We restrict the class of trajectories by imposing these additional set of constraints:

$$\dot{z} \leq \dot{z}_{max} \quad \dot{x}_h(0) = 0 \quad \dot{x}_h(t_f) = \dot{x}_{target}(t_f) \\ x_h(t_f) = x_{target}(t_f)$$

The above constraints provide a lower bound on the time of flight<sup>2</sup> i.e, the time of flight for the helicopter can never be less than  $t_{min}$  where  $t_{min}$  is given by

$$t_{min} \geq \frac{-4a_2 + \sqrt{4a_2^2 - 12a_3a_1}}{6a_3} \quad (2)$$

$$V_{max} \leq \frac{x}{t_{min}} \quad (3)$$

We assume that the helicopter has to intercept the target and land on it at a distance of  $X$  meters [See Figure 4]. Initially the helicopter is at a height of  $z_h$  from the ground. It

<sup>1</sup> $t = 0$  is the time when the helicopter first acquired the target

<sup>2</sup>We only start landing trajectories after we have determined that  $\dot{z}$  over the entire trajectory is less than  $\dot{z}_{max}$

has to land on a target at a distance of  $x$  meters and at a height of  $z_c$  from the ground. Since the maximum velocity of the helicopter is given by  $z_h$  and has to follow the cubic spline trajectory given by equation 1, the minimum time needed for the helicopter to land is given by equation 2. Hence the maximum velocity of the target is bounded by  $V_{max}$  given by equation 3. This can be seen in figure 4.

Since the altitude is obtained from a cubic spline interpolation, the first and the second derivatives exist and are continuous. For landing on a moving target the helicopter altitude is required to follow the above profile with a specified altitude clearance of  $z_c$ .

$$z = g(t) \quad (4)$$

In Equation 4,  $z$  is the helicopter altitude.

### B. Equations of Motion

A kinematic model of the helicopter will be employed for finding the optimal controls for following the trajectory as specified by the cubic spline formulation. To a degree results from this analysis can be corrected (for using dynamics of the helicopter) using singular perturbation theory [15]

The simplified equations of motion of the helicopter in  $x, y, z$  dimensions are given by

$$\dot{x}_i = V \cos \psi \quad (5)$$

$$\dot{y}_i = V \sin \psi \quad (6)$$

where  $V$  is the vector summation of the velocities in  $x, y, z$  directions and  $\psi$  is the heading of the helicopter.<sup>3</sup>

In the above equations the variables  $x$  and  $y$  represent the position of the helicopter in the  $x$ -axis and  $y$ -axis respectively. Also  $g_x$  and  $g_y$  represent the partial derivatives of equation 4 with respect to  $x$  and  $y$  respectively. We assume that the initial and the final positions of the helicopter are specified to us.

The cost equation used for this problem is

$$J = \int_0^{t_f} [(1-K) + Kg(t)] dt \quad (7)$$

In the above equation the function  $g(t)$  is given as a function of time and position. Also  $K$  can vary between 0 and 1 and determines the relative importance of time with respect to the glide slope in terms of optimization. When  $K = 0$  the equations are optimized with respect to time. When  $K = 1$  the path is optimized with respect to the trajectory following capability.

### C. Optimal Control

For finding the optimal trajectory we use the Hamiltonian [16]. The Hamiltonian equation with respect to the above cost function is given by

$$H = 1 - K + Kg(t) + \lambda_x V \cos \psi + \lambda_y V \sin \psi \quad (8)$$

<sup>3</sup>Roll and pitch are assumed to be negligible in this formulation

The equations governing the moving target are given by [17]

$$\dot{x}_{tg} = V_{tg} \cos \psi_{tg} \quad (9)$$

$$\dot{y}_{tg} = V_{tg} \sin \psi_{tg} \quad (10)$$

In all the above expressions it is assumed that the velocity and heading are known at all times. The moving target presents a new boundary condition given by

$$\psi(t_f) = \left[ \begin{array}{c} x(t) - x_{tg}(t) \\ y(t) - y_{tg}(t) \end{array} \right]_{t=t_f} \quad (11)$$

For the above condition to be true the Hamiltonian equation should satisfy

$$H(t_f) = -\lambda^T \left[ \frac{\partial \psi}{\partial t} \right] = V_{tg} [\lambda_x \cos \psi_{tg} + \lambda_y \sin \psi_{tg}]_{t=t_f} \quad (12)$$

The Euler-Lagrange equations for the optimal control problem are given by

$$\dot{\lambda}_x = -\frac{\partial H}{\partial x} \quad (13)$$

$$\dot{\lambda}_y = -\frac{\partial H}{\partial y} \quad (14)$$

with the optimality condition given by

$$\frac{\partial H}{\partial \psi} = 0 \quad (15)$$

yielding the below equations

$$\lambda_x = \lambda_y \frac{\cos \psi}{\sin \psi} \quad (16)$$

Since the initial and final conditions of all the states are specified, the costates are free at the boundaries. The differential equations 6 and 14 together with the optimality condition given by Equation 15 constitute a two point non-linear boundary value problem, which can be solved if the initial conditions on the costates  $\lambda_x$  and  $\lambda_y$  are known.

The solution procedure is further simplified by the fact that the variational Hamilton does not depend on time. Hence one has

$$H(t) = 0 \quad 0 \leq t \leq t_f \quad (17)$$

Solving the above gives us the values of the costates as:

$$\lambda_x = \frac{-(1-K + Kg(t)) \cos \psi}{V} \quad (18)$$

$$\lambda_y = \frac{-(1-K + Kg(t)) \sin \psi}{V} \quad (19)$$

The condition that at time  $t = t_f$  the helicopter should land on a moving target can be expressed by substituting the costates in Equation 12

$$H(t_f) = \left[ \frac{V_{tg} [1 - K + Kg(t)] \cos(\psi - \psi_{tg})}{V} \right]_{t=t_f} \quad (20)$$

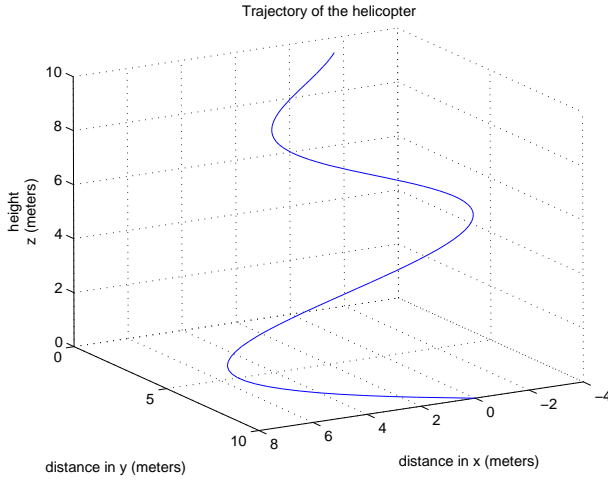

(a) Trajectory of the helicopter

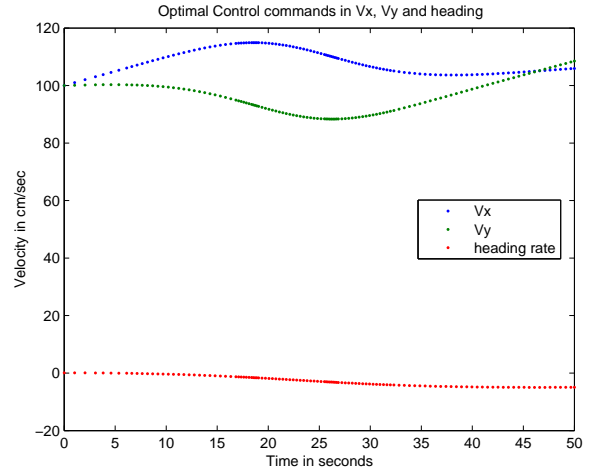

(b) Control commands to the helicopter

Fig. 5. The helicopter trajectory and control commands while landing a target. The position and velocity of the target are known beforehand.

From Equations 15 and 19 one can find the optimal control for heading to be

$$\dot{\psi} = \frac{\cos \psi [K\dot{g} + V^2]}{[1 - K + Kg(t)] \sin \psi} \quad (21)$$

Now consider the second control variable, viz the helicopter speed. Since the second control variable  $V$  appears linearly in the variational Hamiltonian and is bounded, the optimal control is given by

$$V = V_{max}, \quad \text{if } S < 0 \quad (22)$$

$$V = V_{min}, \quad \text{if } S > 0 \quad (23)$$

$$V = \text{Singular}, \quad \text{if } S = 0 \quad (24)$$

where  $S$  the switching function is given by

$$S = \frac{\partial H}{\partial V} \quad (25)$$

After substitution and simplification we get

$$S = \frac{-(1 - K + Kg(t))}{V} \quad (26)$$

Since  $V$  is always positive the sign of the switch function is determined by the term within the braces. This term is always less than zero by definition ( $0 \leq K \leq 1$ ,  $0 \leq g(t)$ ). This expression suggests that the maximal speed setting is optimal throughout the trajectory.

Once the control variables  $V$  and  $\psi$  are found out, we can track arbitrary trajectories for landing. Given the trajectory of the target and the final time/position to land on the target optimal trajectories can be found using Equations 21 and 24.

### III. TRAJECTORY TRACKING

Simulation results are presented where the helicopter is asked to track a target moving in a straight line trajectory and also a spiral trajectory. The simulation results show that the helicopter is able to follow the specified trajectories to land on the target<sup>4</sup>.

Figure 5(a) shows the trajectory of the helicopter in  $x-y-z$  plane while following a target. The target is moving with a constant change in heading (with a heading rate of 0.1 rad/sec) for 50 seconds. The optimal control commands for the helicopter to follow the trajectory are shown in Figure 5(b). The helicopter follows almost a constant velocity of 1 meter/sec and a heading rate of 0.1 rad/sec to track the target and land on it. The descent trajectory is the spiral shown in Figure 5(a).

In Figure 6(a) another target trajectory is shown and the associated control commands to the helicopter are shown in Figure 6(b). The maximum and the minimum velocities for both the simulations were set at 0 m/sec and  $\sqrt{2}$  meters/sec. The plots show the components of the velocities in  $x$  and  $y$  directions but the magnitude of the velocity  $\sqrt{(v_x^2 + v_y^2 + v_z^2)}$  always remains the same<sup>5</sup>.

### IV. EXPERIMENTAL RESULTS

In order to validate our algorithm, we performed experiments with the USC AVATAR shown in Figure 1

We performed initial trajectory control experiments where the helicopter is asked to follow a particular trajectory with a specified velocity. To test the trajectory controller we assumed that the helicopter was tracking an imaginary target and the helicopter had perfect knowledge of the target's position and velocity. Since we have previously performed accurate target tracking [5] we believe that this assumption is

<sup>4</sup>In these simulations the position and velocity of the target are known beforehand

<sup>5</sup>From equations 24 this is to be expected

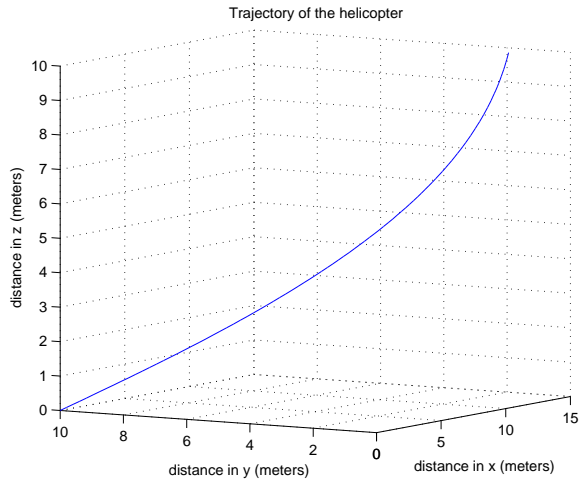

(a) Trajectory of the helicopter

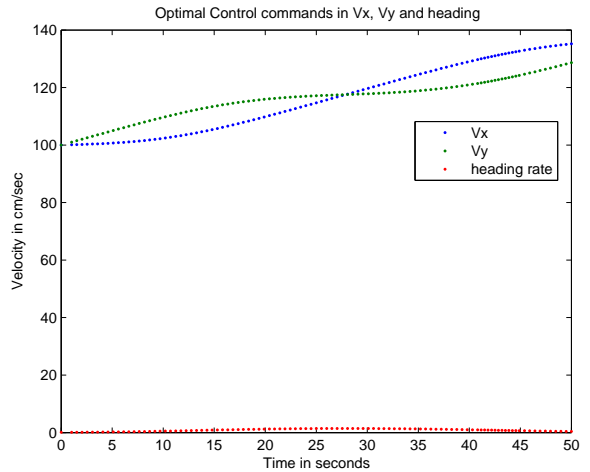

(b) Control commands to the helicopter

Fig. 6. The helicopter trajectory and control commands while landing a target. The position and velocity of the target are known beforehand.

valid. Also the main theme of this paper is trajectory control and hence we removed target tracking.

The helicopter was hovered manually at a height of 15 meters above ground level. The helicopter was in autonomous hover mode and then commanded to move 20 meters laterally with a speed of 4 m/s. Results from this experiment are shown in Figures 7(a) and 7(b).

In Figure 7(a) the helicopter starts from hover and is asked to move laterally by a distance of 20 meters and then hover again. The velocity increases to 5 m/s and then stays constant till the helicopter reaches the position (20 meters offset laterally from initial position) and then drops back to 0 meters/sec. This is consistent with equation 24 where the velocity is predicted to go to a maximum value and then drop to the minimum value. The position of the helicopter during this time is shown in Figure 7(b)

#### A. Simulated Landing Experiments

To simulate actual landing of the helicopter on a moving target, we performed simulations where the target position and velocity were unknown. An estimator was used to continuously estimate the position and velocity of the target. Then using Equations 1 and 2 a cubic spline trajectory is constructed. Once such a trajectory is formulated the optimal heading and velocity controls for the helicopter to track that trajectory given by Equations 21 and 24 are used to find the heading and velocity controls for the helicopter. Those controls are used for tracking the target and then landing on it.

Figure 8(a) shows the simulated trajectory followed by the helicopter while tracking the target. Note that in this plot the target's position is not always known to the helicopter as was assumed in previous sections. A Kalman filter [18] is being used to predict the trajectory of the target and the helicopter is tracking that trajectory. The plot shows the trajectory of the target (solid) and the trajectory of the helicopter (dashed). As can be seen the helicopter is able to track the target quite

well. Figure 8(b) shows the height of the helicopter with respect to time.

## V. CONCLUSIONS AND FUTURE WORK

### A. Conclusions

This paper describes the design of an algorithm for landing on a moving target using an autonomous helicopter. We have previously shown how to track a target from a helicopter. This paper shows the trajectory planning and controller for landing the helicopter on the target. We use a kinematic model of the helicopter to design an optimal trajectory controller for the helicopter based on the variational Hamiltonian and Euler-Lagrange equations. The trajectory controller thus designed is shown to track arbitrary trajectories for landing the helicopter on a moving target. Simulation results are presented that show that the helicopter is able to track a straight line as well as a spiral trajectory of the helicopter. Finally real-life results are presented that show the helicopter following a pre-specified trajectory parameterized by position and velocity inputs.

### B. Future Work

We are in the process of integrating the trajectory planner with our previous Kalman filter implementation to land the helicopter on a moving target (for example on the back of a moving truck). We would also like to incorporate dynamics of the helicopter into our model. Although incorporating dynamics into the model has the drawback that no closed form solution for optimal trajectories exists, using numerical approximations we would like to test the accuracy of the simplified kinematic model that we have used.

## ACKNOWLEDGEMENTS

This work was supported in part by the National Science Foundation under grants CNS-0540420, CNS-0520305, and CCF-0120778. We thank Alan Butler (our pilot) and



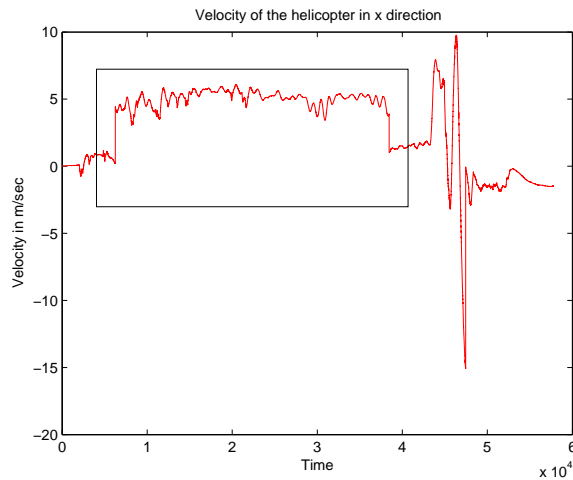

(a) Helicopter velocity in lateral direction. The box represents the region of interest. The velocity stays constant for the entire tracking period as predicted in section II

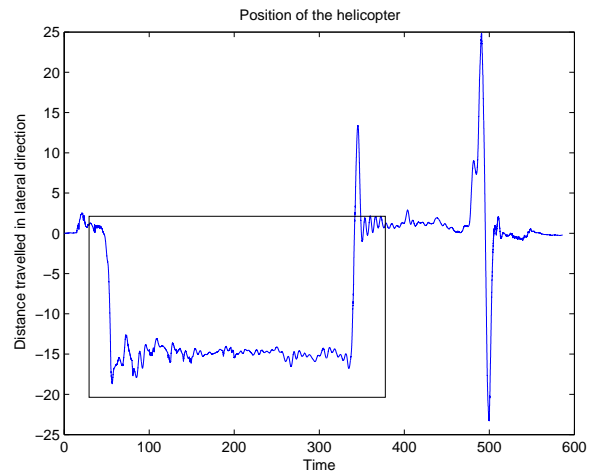

(b) Position of the helicopter in the lateral direction. The box shows the time during which the helicopter follows a straight line trajectory

Fig. 7. Experimental results from trajectory tracking from the AVATAR helicopter.

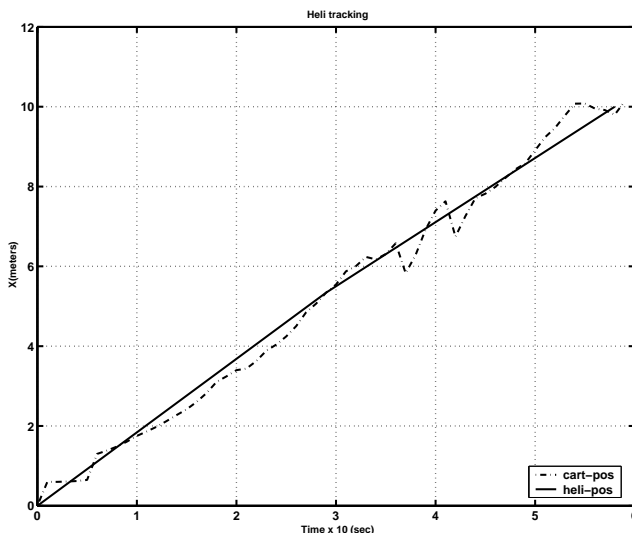

(a) Trajectory of the helicopter (solid line) and the target trajectory (dashed) in the x-direction

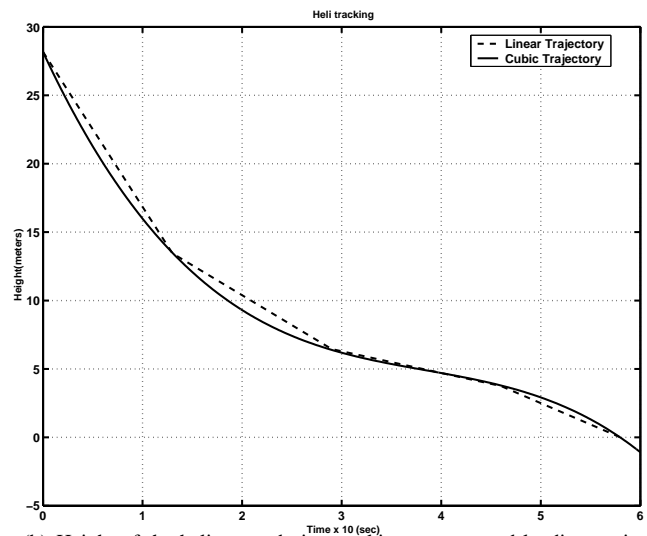

(b) Height of the helicopter during tracking a target and landing on it

Fig. 8. Simulated experimental results where the position of the target was estimated using a Kalman filter.

Jonathan Kelly, for support with flight trials and Marin Kobilarov for reviewing the derivations.

## REFERENCES

- [1] Office of the Under Secretary of Defense, "Unmanned aerial vehicles annual report," Defense Airborne Reconnaissance Office, Pentagon, Washington DC, Tech. Rep., July 1998.
- [2] O. Amidi, "An autonomous vision-guided helicopter," Ph.D. dissertation, Robotics Institute, Carnegie Mellon University, 1996.
- [3] V. Gavrilits, I. Martinos, B. Mettler, and E. Feron, "Control logic for automated aerobatic flight of miniature helicopter," in *AIAA Guidance, Navigation and Control Conference*, Monterey, CA, USA, Aug 2002.
- [4] P. Talbot, B. Tingling, W. Decker, and R. Chen, "A mathematical model of a single main rotor helicopter for piloted simulation," NASA TM 84281, Tech. Rep., 1982.
- [5] S. Saripalli, J. F. Montgomery, and G. S. Sukhatme, "Visually-guided landing of an unmanned aerial vehicle," *IEEE Transactions on Robotics and Automation*, vol. 19, no. 3, pp. 371–381, June 2003.
- [6] University of Southern California Autonomous Flying Vehicle Homepage, "http://www-robotics.usc.edu/~avatar."
- [7] A. E. Bryson and Y. C. Ho, *Applied Optimal Control*. Hemisphere, 1975.
- [8] S. Hutchinson, G. D. Hager, and P. I. Corke, "A tutorial on visual servo control," in *IEEE Transaction on Robotics and Automation*, vol. 12(5), October 1996, pp. 651–670.
- [9] Y. Ma, J. Kosecka, and S. S. Sastry, "Vision guided navigation for a nonholonomic mobile robot," *IEEE Transactions on Robotics and Automation*, vol. 15, no. 3, pp. 521–537, June 1999.
- [10] Y. Bar-Shalom and W. D. Blair, *Multitarget-Multisensor Tracking: Applications and Advances*. Artech House, 1992, vol. 3.
- [11] S. Saripalli, J. F. Montgomery, and G. S. Sukhatme, "Vision-based autonomous landing of an unmanned aerial vehicle," in *IEEE Inter-*

- national Conference on Robotics and Automation*, Washington D.C., May 2002, pp. 2799–2804.
- [12] O. Shakernia, Y. Ma, T. J. Koo, and S. S. Sastry, “Landing an unmanned air vehicle: vision based motion estimation and non-linear control,” in *Asian Journal of Control*, vol. 1, no. 3, September 1999, pp. 128–145.
  - [13] P. K. Menon, E. Kim, and V. H. L. Cheng, “Optimal trajectory synthesis for terrain-following flight,” *Journal of Guidance Control and Dynamics*, vol. 14, no. 4, pp. 807–813, August 1991.
  - [14] E. Kim, “Optimal helicopter trajectory planning for terrain following flight,” Ph.D. dissertation, Georgia Institute of Technology, 1990.
  - [15] S. Twigg, A. J. Calise, and E. N. Johnson, “On-line trajectory optimization for autonomous air vehicles,” in *AIAA Guidance Navigation and Control Conference*, no. AIAA-2003-5522, Austin, TX, August 2003.
  - [16] T. Kailath, *Linear Systems*. Prentice-Hall Inc, 1980.
  - [17] R. Issacs, *Differential Games*. John Wiley and Sons, 1965.
  - [18] R. E. Kalman, “A new approach to linear filtering and prediction problems,” *Trans ASME*, vol. 82, no. D, pp. 35–45, March 1960.
  - [19] R. Bellman, *Dynamic Programming*. Princeton University, 1957.
  - [20] P. K. A. Menon, A. J. Calise, and S. K. M. Leung, “Guidance law for spacecraft pursuit-evasion and rendezvous,” *AIAA Guidance Navigation and Control*, 1988.
  - [21] G. K. F. Lee, “Estimation of the time-to-go paramter for air-to-air missiles,” *Journal of Guidance Control and Dynamics*, vol. 8, no. 2, pp. 262–266, April 1985.
  - [22] N. Rajan, U. R. Prasad, and N. J. Rao, “Pursuit-evasion of two aircraft in a horizontal plane,” *Journal of Guidance Navigation and Control*, vol. 3, no. 3, pp. 261–267, May 1980.