

Development of a Portable Water Quality Sensor for River Monitoring from Small Rafts

James Schneider, Lane E. Schultz, Sophie Mancha, Eric Hicks and Ryan N. Smith[†]

Abstract—The 2015 Gold King Mine spill exposed the Animas River (located in Durango, Colorado) to over 3 million gallons of toxic water with spiked levels of arsenic and lead among other metals. In response to public concern for the quality of the river’s water, a water quality monitoring system has been developed and deployed. Multiple organizations, both local and federal, have joined forces to understand the effects of the spill, and develop a method for continued sampling and remediation. However, most of the sensor network implemented consists of static sensors at conveniently located or easily accessible locations.

In this paper, we present a prototype sensor that enables easy and inexpensive sensing capabilities along the entire river, not just fixed locations. The main idea behind the design is that it can be attached to recreational *ships of opportunity*, e.g., river rafts, kayaks, etc. to continuously gather data as it is *float*ed down the river. Our prototype Lagrangian sampling device is currently able to continuously measure temperature, pH, and oxidation reduction potential at multiple locations along the river. The unit is completely modular, with the ability to integrate different or more sensors as different water quality concerns present themselves. Additionally, operation is simple with a single push-button switch to active and deactivate the device; allowing a complex water sampling device to be implemented by a broad range of citizen scientists and community members wanting to be involved in river monitoring.

Data acquisition is presented from multiple floats through a segment of the Animas River and water quality data are shown through a developed graphical interface in Google Maps. Due to the massive Gold King Mine spill, understanding the current water quality and predicting future impacts in the Animas River is essential. The developed prototype not only brings awareness, but also involvement to the community on the importance of clean water in river ecosystems.

I. INTRODUCTION

In August 2015, a spill of approximately three million gallons of toxic water from the Gold King Mine in Silverton, Colorado flowed into the Animas River in Southwest Colorado, see Fig. 1. High levels of arsenic, lead, zinc, iron, and copper were recorded by the Environmental Protection Agency (EPA), leading to a restriction of water collection for potable uses. This event generated an incentive for local communities to sample and collect data concerning water quality. The Animas River is a highlight and a large attraction of

the town of Durango. In fact, Durango means "water town" and the Animas River is a major contributor to the town’s economy [1].



Fig. 1. The Gold King Mine spill changed the color of the Animas River to a yellow brown.

Aside from providing drinking water, a primary economic revenue source of the Animas River is from rafting and kayaking. The majority of locals either own some type of boating vessel to go down the river or have a favorite spot for weekly trips. The river is used for drinking water, agriculture, and to generate a large amount of power throughout the town [1]. During the summer, the Animas River is a location for social gatherings and relaxation. The Animas River is a major asset to Durango due to its beauty, excitement, and ability to provide life to surrounding nature.

When the Gold King Mine spill contaminated the Animas River it created social and economic strife. Continued and persistent water quality testing in the Animas and surrounding rivers is needed. Existing sampling efforts in the river are comprised of static sondes at easily-accessible locations. This sampling method provides a limited perspective of a dynamic environment and cannot accurately account for flux associated from tributaries along the river. Increasing data density for this sampling method is attained by placing more sensors at

Authors are associated with the Robotic GNOME Laboratory, Department of Physics and Engineering, Fort Lewis College, Durango, CO 81301, USA

[†]Corresponding author: rsmith@fortlewis.edu.

strategic locations, however this increases both costs and resources. Furthermore, Colorado has strict water rights that disable communities of interested parties from testing at any location along the river [2]. Hence, a need exists for a relatively cheap and easy-to-use sampling device to acquire daily water quality data continuously over large sections of the Animas River.

To this end, An annular device capable of gathering pH, temperature, oxidation reduction potential (ORP), and GPS data was designed and is shown in Fig. 2. This sensor is capable of logging at a maximum 0.5 Hz, can operate continuously for more than 6 hours, can withstand an impact of a 2 meter drop, and can survive a river environment as it has been tested and validated several times in the Animas River. The data stored to an SD card in the prototype. This design is meant to be attached easily to a kayak or river raft by scientists and interested community members to gather data on the health of the river system.

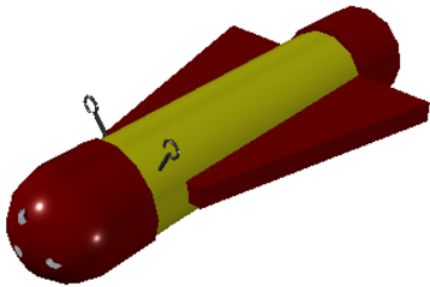

Fig. 2. CAD model of the fully-assembled, water sampling prototype.

II. RELATED WORK

There are other devices similar to our proposed prototype. For instance, the University of Virginia built an automated water quality monitoring system along the West and Rhode rivers flowing into the Chesapeake bay in 2009 shown in Fig. 3. This project suggested using several stationary sites that transmits data throughout the year and use Lagrangian sensors to create a model of the river [3] complimenting the data taken by Eulerian sensors. The unit price of this instrument is \$1,220 dollars without sensors. Adding sensors can cost up to \$100 - \$400 each, depending on the chosen sensor package [4]. There are similar sampling systems in place, however the bulk of the data are being taken from several fixed points. However, our prototype was designed to have the bulk of its data acquired from a sensor package that was attached to a river raft, which took data



Fig. 3. University of Virginia Multiparameter Eulerian Water Quality Meter is shown [4].

points within various parts of the river. We designed our prototype to replicate the existing static sensors in the river so that data from each static node could be connected to understand the impact of long sections of river. For example, are contaminants being added by a community on a section of the river, or are certain locations sinks for some nutrients or contaminants. Additionally, we intend that our prototype will be used by the general public to help gather data daily along the majority of the river; something that cannot be done by a single research group or static sensor network.

The University of Virginia proposed the Professional Plus Multiparameter Instrument (Pro Plus) as one portable system for monitoring water quality. Integration of the sensor into a known river system is difficult due to the size of the device and its capabilities for placement as a primarily Eulerian device.

Another similar project is the autonomous aquatic vehicle designed by Georgia Tech's which is shown in Fig. 4. This vehicle is similar to this project in its ability to take data in most freshwater locations. Similarly, it floats above the surface of the water while sensors are submerged to collect data. The autonomous robot developed at Georgia Tech is 16 feet long, mobile, and can operate remotely or in fully-autonomous mode. This device has the capability of closely monitoring the shore of a lake completely unassisted. It uses video technology to evaluate and maintain exact distances between the shore and the aquatic vehicle, while moving at a constant speed [5]. The aquatic



Fig. 4. Georgia Tech's Autonomous Aquatic Vehicle is shown [5].

vehicle takes overlapping photos and can stop or move autonomously throughout the changing seasons [5]. It also has the means for interchangeable sensors. However, this would not be ideal for the Animas River. This particular aquatic vehicle is too large to be safely taken down a river. It cannot withstand large amounts of force nor stay intact through heavy flow of water. Conversely, our device can handle turbulence from the Animas River while being dragged by the end of a raft. Furthermore, there are ships of opportunity in the Animas River for attaching the proposed prototype. This means there is no need for autonomous operation.

Currently, the Colorado River Watch Network (CRWN) has a system for testing the quality of water in rivers. This organization assigns volunteers to go to predetermined locations along Colorado rivers and collect samples. The samples are taken to professional labs for analysis. CRWN follows EPA guidelines and tests four main categories: dissolved oxygen, temperature, pH, and specific conductance [6]. CRWN also requires volunteers to collect samples at the same location once a month for the duration of 12 months. This is due to a river's dynamic water flow, and the fact that testing a single static location will not accurately reflect the quality of the overall river. It is important to fill in the gaps of spatial data distribution. This reflects the utility of the designed prototype as it can gather data germane to water quality of the entire river rather than a single portion. While this involves the community in water quality monitoring, it still only takes acquisitions at on location. Our project will involve the community in a way that creates a much higher density of data. This creates the opportunity to gain much more pertinent data.

Another comparable project is the Autonomous Surface Vehicle (ASV) designed by Autonomous Systems Laboratory located in Kenmore, Australia. This device is unique in that it is powered by a solar panel located directly on top of the device shown in Fig. 5. It



Fig. 5. Solar Powered Autonomous Surface Vehicle [7].

possesses similar qualities as our project such as the ability to detect temperature, GPS location, pH and dissolved oxygen. This device is more advanced than others due to its ability to run continually (due to the solar panel) and detect its surroundings and boundaries [7]. However, this device can not run through a high flowing river, such as the Animas. It is large in size and would not be ideal for the needs of Durango. Currently, no robotics alternative has been developed to navigate a river autonomously, as this is an incredibly difficult task .

The common theme of stationary devices for water quality monitoring only strengthens the urgency for a water quality device with Lagrangian capabilities that can handle the harsh flow of rivers. Our device has been demonstrated to achieve this goal and is affordable and easy to operate. Hence, we can get multiple sensors into the hands of many community members to get frequent analysis of the dynamic river environment.

III. VEHICLE DESIGN

A. Capabilities

Developing a device that is capable of Lagrangian water quality monitoring produced three conceptual prototypes. Pumping systems, a rigidly mounted sensor apparatus, and a vessel integrated design were all considered. However, the simple *tow-behind* concept was pursued for the final prototype as it meets all of the design criteria. The annular prototype has been initially outfitted with four basic sensors: pH, temperature, ORP, and GPS. Data collection rate is currently set to 0.5 Hz. The total cost of this instrument, including all the sensors, was \$480.

An extended battery life is essential to the device as it allows for data acquisition over longer distances. As the river has numerous associated issues stemming from the spill, a device that has the ability to expand its sensor array is essential to the quality of data and research. To allow a wider range of users (researchers, government

employees, etc.), it is important that the device be easy to use and inexpensive. To ensure a secure investment and maintain the idea of the device having a "long-life", the device must be durable and be able to withstand the intense rapids of the Animas River. Lastly, the device must be portable and easy to use for a single person.

In evaluating the design options the pumping system was unable to meet the power requirements as well as data acquisition requirements. As it is a dynamic sensor, by the time the water reaches the sensors for acquisition, the GPS location would no longer be valid thus making the data inaccurate. The rigidly mounted device, while equally as capable as the tow behind system, presented safety risks that were unavoidable. The rigidly mounted device posed the issue of dragging fallen passengers who get caught by the mount, thus risking the passengers safety. It was of the discretion of the design team and rafting companies alike that this design not be further pursued. Therefore, as previously stated, the *tow-behind* design was chosen for development.

An objective was to design a water quality measurement device that a member of the general public could operate with minimum setup and supervision. The system is robust and has handled class 1 rapids with no sign of malfunction or damage. It can sustain impacts with rocks and other debris in the water due to its protective outer hull.

B. Functionality

The annular prototype is based on the capability of being attached to a third party raft as shown in Fig. 6. Third parties, such as Mild to Wild [8] and the Durango Rafting Company [9] make numerous trips throughout the same body of water seasonally. After discussion with these local companies tactics for ease of uses were determined. Theoretically, someone interested in researching the water quality of the river could enter a cooperative partnership with third-party rafting companies by lending the annular prototype to gather data.

The device is powered on by a push-button Boolean latch on the rear of the instrument. This activates all the electronics and sensors allowing data to be recorded to the Micro-SD card. The device is then powered off by deactivating the button. There is no required intervention other than the activation and deactivation of the switch for gathering data.

The user can attach the annular prototype via the prepared rope extending from eye bolts on top of the



Fig. 6. Floating tests were done in the Animas River using an inflatable raft similar to the raft shown above.

prototype to the rear of the desired vessel. The eye bolts must remain upright when the prototype is placed in the water to ensure proper flow orientation. This orientation provides minimal shielding of the GPS allowing for sustained and accurate satellite communication.

C. Mechanical

The majority of components used for housing the prototype were made of Schedule 40 PVC pipe (Fig. 7) . To secure the electronics inside the inner annulus, custom parts were machined and 3D printed. These parts were sized for pairing with 3D printed ABS plastic. These parts include the structural support of the electronics compartment and the rigid components maintaining stability between the annulus and the outer cylinder. Structural support components form to the contours inside the pipe ensuring the security of the electronics. The arduino, SD card reader, GPS sensor, ORP circuit, and perfboard were screwed on to the 3D printed parts to establish rigidity of internal components. This allows for ease of exit and entry of the electronics while allowing space for wiring. Figure 7 shows the 3D printed electronic mounting platform.

Attached to the outer cylinder are two eye bolts as shown in Fig. 7. These eye bolts were screwed in and are held in place by nuts on the interior and exterior of the protective outer cylinder. Power Cinch Knots can be tied with nylon rope to the eye bolts [10]. The other ends of the ropes can be tied to locking carabiner clips that are attachable to existing rope tie locations on most standard rafts as shown in Fig. 6. Also attached to the outer cylinder are two foam board fins (made of

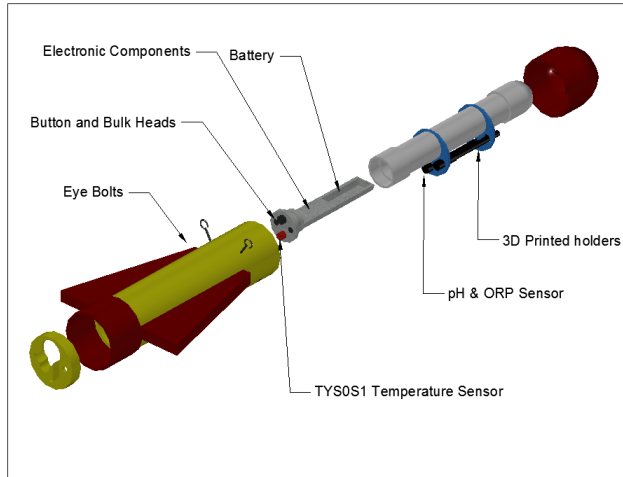

Fig. 7. Electric components were mounded on a 3D printed plastic platform that was placed inside an inner cylinder within an outer cylinder.

common stucco foam) that allow the prototype to keep the proper orientation and submersion depth during hydrodynamic operations. The fully assembled annular prototype is shown in Fig. 8.

Two 3D printed holders, also comprised of ABS plastic, were designed to provide support between the inner annulus and the containment cylinder as shown in Fig. 7. This allows for the inner annulus to be extracted and reintroduced to the containment cylinder with ease. Holes in these rings are primarily used for holding any of the annular prototypes associated sensors as well producing an avenue for water flow. The proper inner cylinder orientation is kept by a key-way attached to the outer cylinder protruding to the inside. The 3D rings

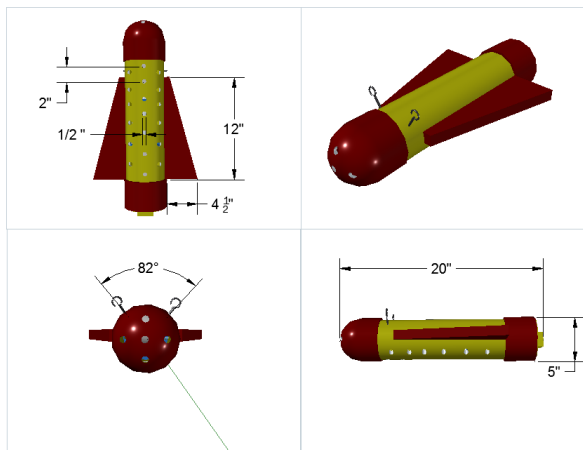

Fig. 8. A protective outer cylinder with holes was used to house the inner cylinder.

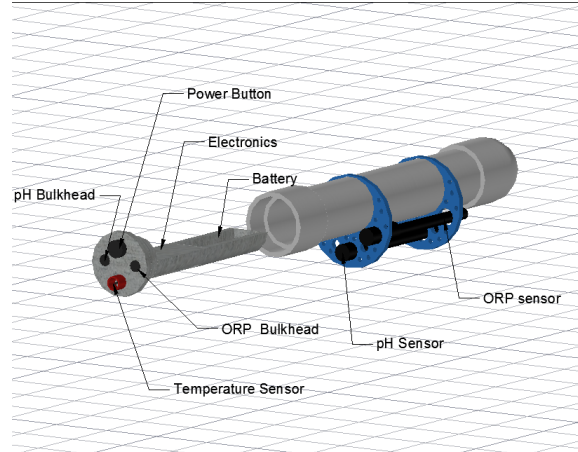

Fig. 9. The general layout of the inner cylinder is shown above.

were slotted accordingly to allow the inner annulus ease of passage in and out of the containment cylinder. A depiction of the inner cylinder can be seen in Fig. 9.

The inner annulus was designed to be impermeable to water. For this, marine grade epoxy was applied to the bulkhead electronic feed throughs, push-button switch, and temperature sensor where each individual component interfaces with the cap. Furthermore, the pH and ORP sensors were further water-proofed by the application of heat-shrink tubing and hot-melt adhesive. The male ports of the sensors were filled with epoxy to prevent water permeation.

The 4-inch diameter containment cylinder of the prototype allows water flow through the inside of the cylinder and around some sensors by having holes on the surface as shown in Fig. 10. The bow of the outer cylinder was capped with a PVC cap that has five drilled holes. The aft of the outer cylinder was capped with a PVC female adapter fitting. A threaded cap with five drilled holes was placed on this fitting. One of the holes was drilled larger than the rest for accessibility to the power button for the electronic components. All holes were drilled to aid in water flow to the pH, temperature, and ORP sensors.

The aft outer cylinder cap is removable to allow the inner annulus to be placed within. A PVC cap was glued to the bow of the inner cylinder and a PVC female adapter fitting was glued to the aft end. One machined cap with threads, two holes for bulkheads, one hole for the temperature sensor, and one hole for an on/off button was placed on the PVC female adapter fitting of the inner cylinder. The cap was made using the threads of a 2 inch PVC male threaded cap and a custom machined cap out of solid PVC. This cap is shown in Fig. 11.

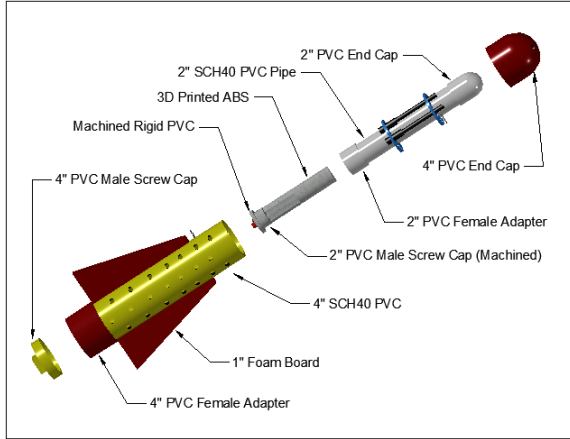

Fig. 10. A protective outer cylinder with holes was used to house the inner cylinder.

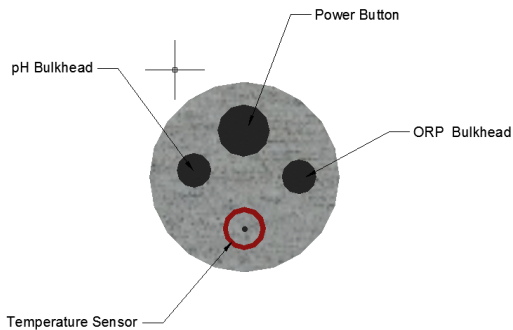

Fig. 11. Cap layout for the inner cylinder.

The submersion depth required for proper device function is approximately 3.5 inches. This was to ensure that temperature, ORP, and pH sensors were submerged in water while keeping the GPS satellite connection. If the GPS sensor inside the prototype sinks below 5 inches of water, connection to satellites is lost.

The fins on the starboard and port side of the annular prototype help keep the vehicle partially afloat and stabilize the device so it does not roll. It was found on preliminary runs that the craft had a tendency to roll as well as dive beneath the water, both of which rendered the GPS inoperable. The addition of the wings not only added stability but also aided in device buoyancy.

D. Sensors

The wiring for the electronics is the schematic in Fig. 12. The following sensitive electronics are housed

within the inner cylinder: 16 GB microSDHC card (Sandisk) [11], arduino (Sparkfun, Arduino Pro Mini, ID: DEV-11113) [12], microSD card reader and writer (Adafruit, MicroSD card breakout board+, ID: 254) [13], one point ORP calibration circuit (EZO ORP Circuit, AtlasScientific) [14], lithium ion 7.4 volt [15], 2200 mAh battery (Sparkfun, ID: PRT-11856), and GPS sensor (Parallax, PAM-7Q GPS Module ID: 28509) [16]. Electronics connected to the inner electronics but outside the inner cylinder are the pH (Sparkfun, ID: SEN-12872) [17], temperature (Celsius Fast-Response, $\pm 0.1C^\circ$ Temperature Sensor (I2C), BlueRobotics) [18], and Oxidation Reduction Potential (ORP Probe, AtlasScientific) [19] sensors as shown in Fig. 7. These outer sensors are attached to the arduino via waterproof bulkheads feed throughs.

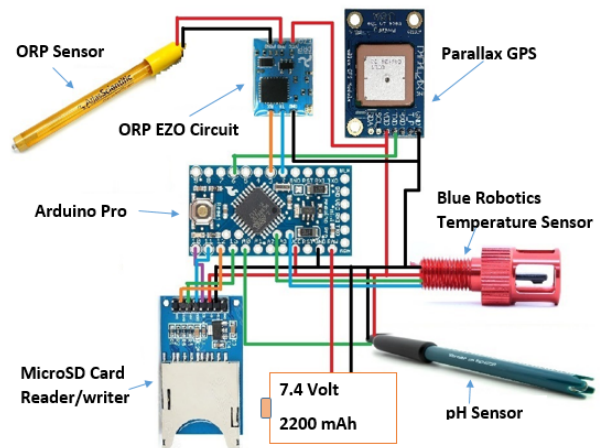

Fig. 12. The wiring diagram for the electronics that measure temperature, pH, GPS, ORP, and velocity is shown above.

The current system has an 80 mA current draw. This gives a running time of 27.5 hours with a 2200 mAh, 7.4 Volt battery. All data is written in the form of an ASCII text file stored on an SD card. The standard format of the saved file allows for the data set to be imported via multiple modes of data analysis like MATLAB or Excel. This is preferred because multiple entities could use the standardized data. This makes it both easy and reliable for users. Additionally, we have written MatLab code for data processing, along with an integration into Google Maps for data visualization.

IV. EXPERIMENTAL VALIDATION

A. Calibration

The factory error of the Parallax GPS (a GPS where the direction may differ when viewed from a different position) is ± 3 meters. There was no attempt to lessen

the error on this particular sensor. The narrowest point in the Animas River is 20 feet wide [20]. This metric makes the GPS's associated error less of a concern considering the inherent accuracy of ± 3 meters keeps data within the bounds of the river at most locations. It is proposed that in future designs, a Kalman filter be applied to reduce navigational error associated with outlying readings [21]. The GPS readings were within an acceptable spatial scale for the required scientific analysis.

The Vernier pH sensor was calibrated using a 3 point calibration model with known pH solutions of 4, 7 and 10. For the model to be considered to demonstrate accurate readings, the curve created between the sensor readings must be linear. The calibration proved to be linear. To continually produce accurate data however, the pH sensor must be routinely calibrated [22]. The inherent accuracy of the pH sensor is a range of ± 0.1 .

The Atlas Scientific ORP sensor was purchased with a pre-calibrated circuit, namely the EZO ORP circuit. This allowed for a one point calibration with a solution provided by the manufacturer. The accuracy given by the manufacturer on this circuit was ± 1 mV [14]. However, as with the pH sensor, a routine calibration must be applied to this sensor to ensure proper function during the sensors lifetime.

The temperature sensor was also pre-calibrated by Blue Robotics [23]. The application of this calibration program yields a ± 0.1 °C accuracy. Routine calibration is required annually.

B. Experimental Setup

To ensure the device functions properly, sensors were properly calibrated according to specifications given by the manufacturers. Furthermore, the device is heavily dependent on maintaining water proof seals in the inner annulus. Hence, Teflon tape was applied to the inner cylinder threads to ensure a proper seal.

As the Animas river is the exigence for developing this prototype, it was chosen as the primary testing location for the device. The device was brought to a common port of entry to the Animas River (about a quarter mile north of 32nd street in Durango, CO 81301). At this location, the device was attached to a river raft. The device was turned on to gather data before entry into the river to ensure functionality. The raft was then commandeered for approximately one mile down the length of the river. After returning to the original location of departure, the device was powered off and

data were analyzed.

The Animas river is considered to be one of the more turbulent rivers in the surrounding area, so it is theorized that device would function similarly in other river ecosystems [8]. Although, if the rivers ecosystem is subjected to sever canopy along the rivers riparian corridor, then different means of attaining localization information might be required to ensure accuracy of data. For example, an IMU could be integrated for dead-reckoning location when GPS is unavailable.

C. Experimental Methodology

The device was designed for the capability of being handed off to parties interested in river quality in various freshwater locations other than the Animas River. The following objectives must be satisfied for the prototype to be considered a viable product: durability, waterproofing, apt water flow, having proper drag orientation, easy attachment, and ease of use. Each of these objectives were tested. To ensure that the device was maintaining proper flow, the device was placed in a flume channel that allowed water to flow throughout the device. A stream line of dyed water was run through the device. The contours of the dye outlined the patterns of flow throughout the device (Fig. 13). Although the exact quantity of the flow rate through the device was not determined, visual inspection establishes that avid flow exists, and the sensors were able to acquire a continuous data stream during the testing process. Proper drag orientation was determined during the initial stages of testing by ensuring the device would not roll or dive during dynamic measurements. Proper flow orientation was ensured by the fins of the device. Ease of use was tested by allowing another student to carryout the testing procedure of setting up and attaching the annular prototype to a raft prior to launch. The setup took less than 5 minutes which satisfied our criteria for ease of use and easy attachment.

The instrument was tested by the following guidelines. These instructions would be given to a third party representative in charge of deploying the device. Steps were developed based on specific requirements needed to test water quality.

- 1) Prior to any attachment, determine the testing location. Once the location is known, the device can be powered on by depressing the push button located at the rear of the instrument.
- 2) Attach the nylon rope from the eye-bolts on the device to secure locations on the rear of the vessel via the provided carabiner clips.



Fig. 13. Flume testing of the prototype

- 3) Once the vessel has returned to shore, the device should be removed by detaching the carabiner clips from the back of the raft and powered off by pressing the button at the rear of the instrument.
- 4) Return the device for further analysis to the appropriate team of researchers.

V. RESULTS

The instrument was turned on at Fort Lewis College in Durango, Colorado, driven down to 32nd street and put on to the back of a raft for approximately half a mile. Figure 14 shows the data after it was plotted on Google Earth. Each GPS point can be selected to display the date, time, velocity in miles per hour (mph), temperature in Celsius, pH, and ORP. We are currently working on a system to archive data to be made publicly accessible.

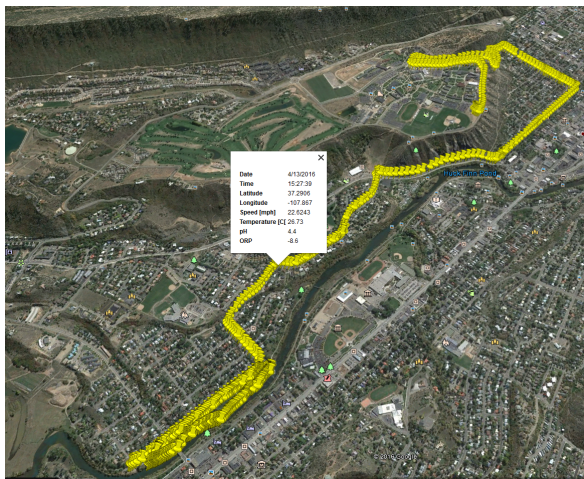

Fig. 14. Data acquisition on the Animas River on April 25, 2016 is shown.

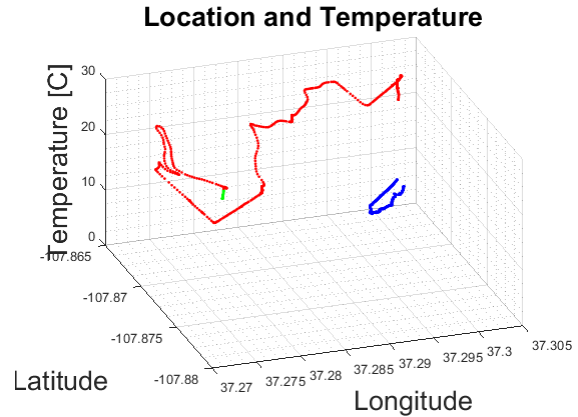

Fig. 15. Corresponding temperature versus GPS location for the testing on April 25, 2016 is shown.

The GPS functioned and maintained a majority of acquisitions inside the river. This is sufficient accuracy as the river section in question can be determined for the supplied GPS location. Data does not significantly change over the error range of the GPS measurement. Taking a measurement at two locations about 3m apart will give similar readings. During the entirety of the travel, data points fell within the desired course. Furthermore, analysis of the GPS data versus the temperature shows the correlation from the time when the device was out of the water until it was placed back. The red points in Fig. 15 are data acquired outside the Animas River while the blue points are data collected within the river.

Data retrieved can be imported to MATLAB [24]. Data can then be displayed using a 3D plot to view how ORP, pH, velocity, or temperature change with respect to longitude and latitude. A color scheme can be programmed to display different ranges of values as different colors. This scheme could show areas of interest. Figure 15 shows an example of this display format.

Additional water sampling data was attained along the route depicted on Fig. 16.

Temperature and location data are shown in Fig. 17. The United States Geological Survey (USGS) states that pH and temperature were 7.8 and 8.0 °C respectively on April 25, 2016 at noon [25]. From data gathered on the run in Fig. 15, the average pH and temperature were 5.8 and 8.8 °C from 12:55 PM until 1:32 PM. Our average pH was on the acidic side. This is most likely an error in calibration of the pH sensor. On the other hand, the average temperature readings closely match that of USGS. Furthermore, data was attained on different times which could skew comparisons.



Fig. 16. Data acquisition on the Animas River on July 15, 2016 is shown.

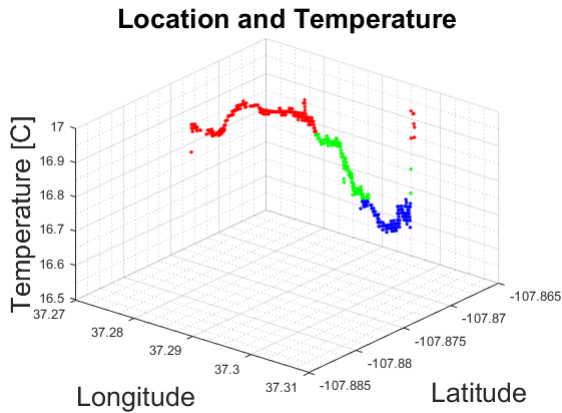

Fig. 17. Corresponding temperature versus GPS location on the Animas River on July 15, 2016 is shown.

The average temperature and pH for data attained on the run related to Fig. 17 was 16.9°C and 4.3 respectively. Data was gathered from 3:28 PM Until 4:23 PM. USGS data shows a temperature of 16.9°C and a pH of 7.8 for July 15, 2016 at 4:00 PM [25]. This data validates temperature measurements. The acidic pH readings do not reflect data attained by USGS and are likely due to an error in calibration.

The more positive an ORP reading is, the more oxidizing agents water will have. The more negative an ORP reading is, the more reducing agents water will have [26]. ORP is not currently measured by USGS, but is an important quality to measure related to the water's ability to oxidize metals in solution. Higher ORP means that metals will precipitate out and not be bio-available and harmful to river life. The needed ORP readings for an aquaculture is 150-250 mV [27]. The average reading of -79.9 mV for ORP in the run shown on Fig. 15 means that the Animas River running through Durango would be poor for farming fish if the instrumentation was functioning properly. This is most likely due to

calibration error. However, the results for testing relating to Fig. 17 gave an average ORP of 239 mV. This falls within the aquaculture capable range. Future data gathering is needed to verify results and consistency.

VI. CONCLUSIONS AND FUTURE WORK

Taking advantage of ships of opportunity, such as rafting companies, will allow ideal ways for collecting data. There is demand for a relatively inexpensive, easy to use, Lagrangian water quality monitoring device for the Animas River. Our proposed prototype can gather pH ranging from 3 to 10, operate for at least 6 hours, withstand a 2 meter drop, measure temperature ranging from 0°C to 30°C , measure location within one meter of accuracy, measure oxidation reduction potential, and gather data at a rate of 0.5 Hz.

Based on the results of the testing data, the prototype can be considered as a final product with the exception of minor enhancements and future development. Such improvements include: incorporating a break off mechanism, a pinger device, collect data at a faster rate, attach an antenna for the GPS sensor, create a third eyebolt for better positioning, as well as make the fins out of fiberglass for better stamina.

The break-off mechanism is crucial for maintaining the acceptance and approval of rafting companies. Without this mechanism, the prototype could potentially be a liability as it could hinder the proper flow of the raft down a river. However, this could lead to the device getting lost. With a break off mechanism, a pinger must be included to ensure the device is not lost.

Another important advancement would be the antenna for the GPS sensor. If the device submerges beyond the GPS data gathering limit, the sensor can no longer track location. Thus, an antenna would enhance orientation data, allowing for the possibility of greater submersion of the device.

A third eyebolt could be used for better positioning of the device. This third eyebolt would be located along the center of the main housing. With the additional support, the likelihood of the device remaining in the proper orientation for the best data acquisition would be increased. It would also balance the device by creating limited mobility.

The rate at which the sensors collect data could be increased. Currently, the rate is 0.5 Hz. Although this rate allows for data to be successfully analyzed, it may not be fast enough depending on the application of the

prototype.

Lastly, the fins could be made out of a stronger material such as fiberglass. This would greatly increase the strength and durability of the device, which is a desired characteristic to possess as the prototype will be exposed to rocks and debris throughout the river.

With a few minor improvements, this device has a great deal of potential for advancements involving monitoring the quality of water. Overall, this is an accomplished system as well as a viable option when looking for an inexpensive water quality monitoring device. It is less expensive than existing products, is easily attachable, and has easy data analysis with SD card management. Although this product can be improved, it is a step forward for understanding river environments with the intention of improving the longevity and health of rivers.

VII. TAKE AWAY

Water quality monitoring is a prioritized necessity for human existence. Without it, ecosystems can dramatically deteriorate due to lack of awareness. The Animas River is 126 miles long, serves as drinking water, is surrounded by numerous irrigation ditches for farmland, home to brown and rainbow trout, and is the only water source to numerous plant life surrounding it. These are a few of the plethora of living organisms that are dependent on rivers. Undoubtedly, the importance of water quality monitoring can have a worldwide impact.

ACKNOWLEDGMENTS

The work in this paper was partially supported by a Byron Dare Junior Faculty Award.

We would also like to thank the local river guides and rafting companies for their support and advise throughout the development of the prototype device.

REFERENCES

- [1] Silver Mountain Web Designs, "Animas River DuranGO Outdoors," 2012. [Online]. Available: <https://www.durangoutdoors.com/lakes-rivers/animas-river.htm>
- [2] "Water Rights." [Online]. Available: <http://water.state.co.us/surfacewater/swrights/pages/default.aspx>
- [3] A. Anvari, et al, "Designing an Automated Water Quality Monitoring System for West and Rhode Rivers," <http://bart.sys.virginia.edu/sieds09/papers/FPM1Env-Eco-01.pdf>, 2009.
- [4] YSI, "Professional Plus Multiparameter Instrument," 2016. [Online]. Available: <https://www.ysi.com/proplus>
- [5] B. Brumfield, "On Their Own," 2015. [Online]. Available: <http://www.rh.gatech.edu/features/their-own>
- [6] Lower Colorado River Authority, "Colorado River Watch Network Water Quality Monitoring," 2012.
- [7] M. Dunbabin, "An Autonomous Surface Vehicle for Water Quality Monitoring," 2009. [Online]. Available: https://www.researchgate.net/publication/46574629_An_Autonomous_Surface_Vehicle_for_water_quality_monitoring
- [8] "Mild to Wild Rafting and Jeep Trail Tours," 2016. [Online]. Available: <https://mild2wildrafting.com/>
- [9] "Mountain Waters Rafting in Durango, Colorado," 2016. [Online]. Available: <https://durangorafting.com/>
- [10] Grog, "Trucker's Hitch (Power Cinch Knot)," 2016. [Online]. Available: <http://www.animatedknots.com/truckers/#ScrollPoint>
- [11] "SANDISK microSDHC CARD," 2016. [Online]. Available: <https://www.sandisk.com/home/memory-cards/microsd-cards/sandisk-microsd>
- [12] "Arduino Pro Mini 328 - 5V/16MHz," 2016. [Online]. Available: <https://www.sparkfun.com/products/11113>
- [13] "MicroSD card breakout board+," 2016. [Online]. Available: <https://www.adafruit.com/product/254>
- [14] "EZO ORP Circuit," 2016. [Online]. Available: http://www.atlas-scientific.com/product_pages/circuits/ezo_orp.html
- [15] "Polymer Lithium Ion Battery - 2200mAh 7.4v," 2016. [Online]. Available: <https://www.sparkfun.com/products/11856>
- [16] "PAM-7Q GPS Module," 2016. [Online]. Available: <https://www.parallax.com/product/28509>
- [17] "Vernier Sensor - pH Sensor," 2016. [Online]. Available: <http://www.vernier.com/products/sensors/ph-sensors/ph-bta/>
- [18] "Celsius Fast-Response, $\pm 0.1^\circ C$ Temperature Sensor (I2C)," 2016. [Online]. Available: <https://www.bluerobotics.com/store/electronics/celsius-sensor-r1/>
- [19] "ORP Probe," 2016. [Online]. Available: http://www.atlas-scientific.com/product_pages/probes/orp_probe.html
- [20] D. Rodebaugh, "The Birth of the Animas, from Headwaters to Confluence," Aug 2011. [Online]. Available: <http://www.durangoherald.com/article/20110828/news01/708289888/the-birth-of-the-animas-from-headwaters-to-confluence>
- [21] E. A. Wan and R. Van Der Merwe, "The unscented Kalman filter for nonlinear estimation," in *Adaptive Systems for Signal Processing, Communications, and Control Symposium 2000. ASSPCC. The IEEE 2000*, 2000, pp. 153–158.
- [22] Vernier, *pH Sensor (Order Code PH-BTA)*. [Online]. Available: <http://www.vernier.com/files/manuals/ph-bta/ph-bta.pdf>
- [23] Measurement Specialties, "TSYS01 Digital Temperature Sensor."
- [24] MATLAB, *version 9.0.0.341360 (R2016a)*. Natick, Massachusetts: The MathWorks Inc., 2016.
- [25] USGS, "USGS 09361500 ANIMAS RIVER AT DURANGO, CO," 2016. [Online]. Available: http://waterdata.usgs.gov/co/nwis/uv?site_no=09361500
- [26] Aqua Health Products, "Understanding ph and orp," 2015. [Online]. Available: <http://www.aquahealthproducts.com/understanding-ph-and-orp>
- [27] OzoneSolutions, "ORP level ozone, ORP levels, ozone, oxidation reduction potential," 2014. [Online]. Available: <http://www.ozoneapplications.com/info/orp.htm>