



Ross Mead  
Interaction Lab  
University of Southern California

# **FROM THE RCX TO THE PR2: STEPS TO BECOMING A ROBOT SCIENTIST**



# Overview

- Review robot computation and competitions.
  - Present some real world applications!
  - This presentation is about *my* journey...
  - I think many of you are on a similar path.
- 

# Computation and Competition

A Decade in Review

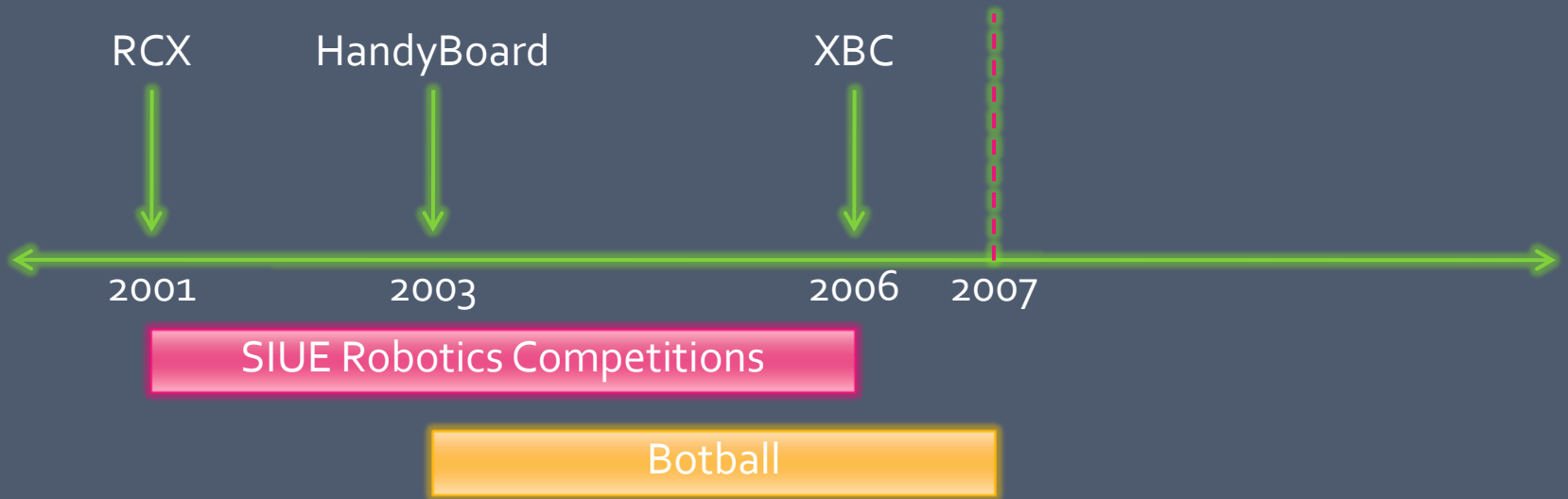
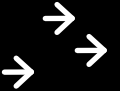

# RCX (2001-2006)





How many of you have worked with an RCX?

# 2001: SIUE Sumo Wrestling

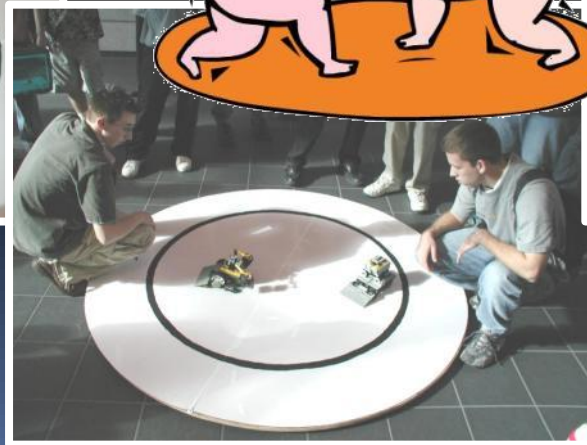
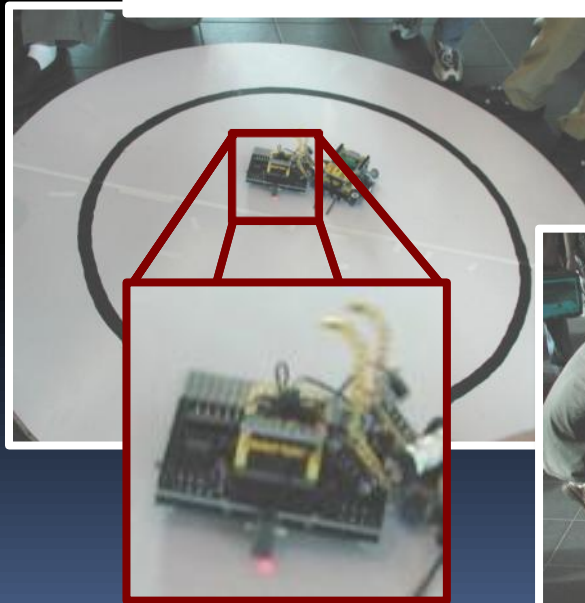
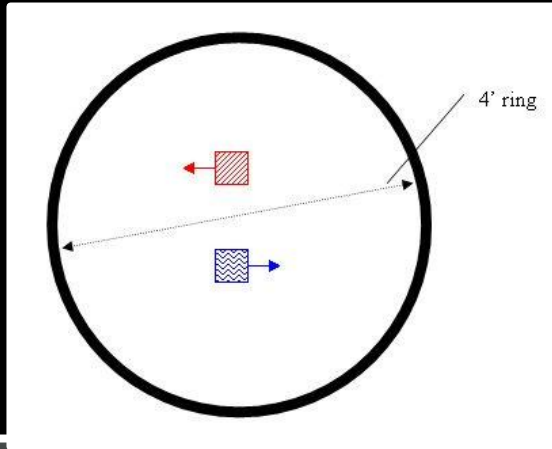

# 2002: SIUE Sumo Wrestling

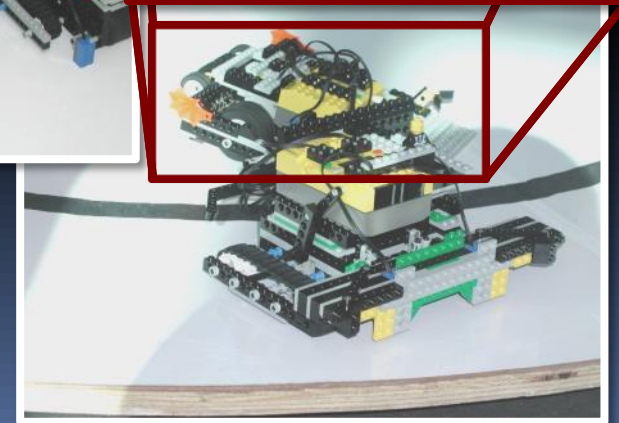
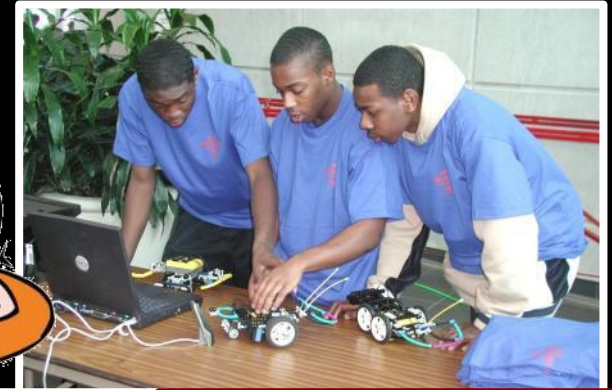

# 2003: SIUE RoboPong

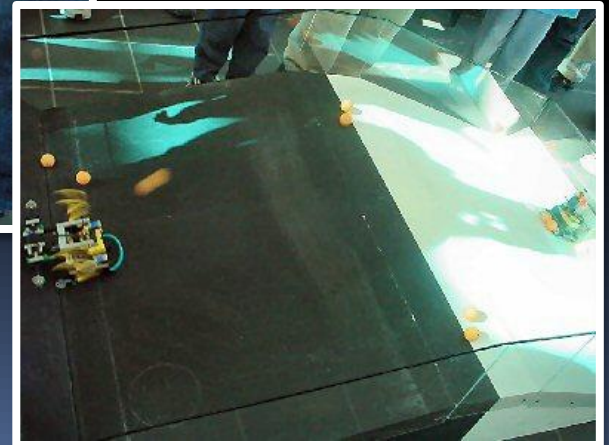
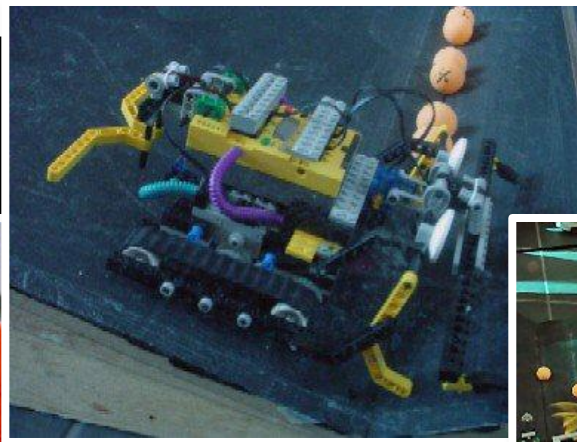
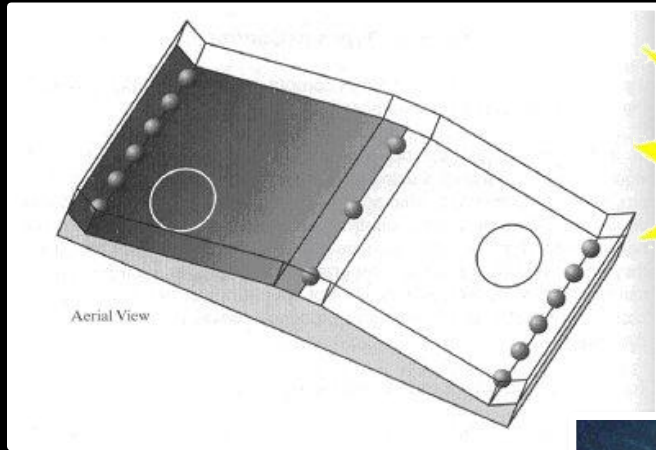



# 2004: SIUE RoboCraft

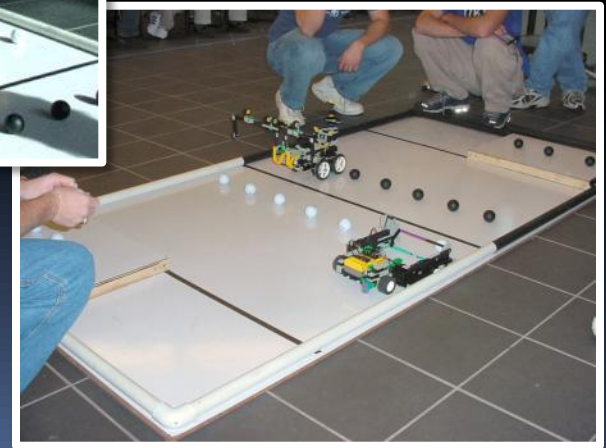
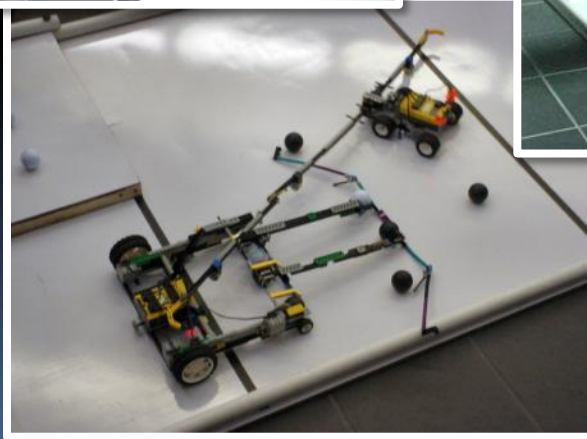
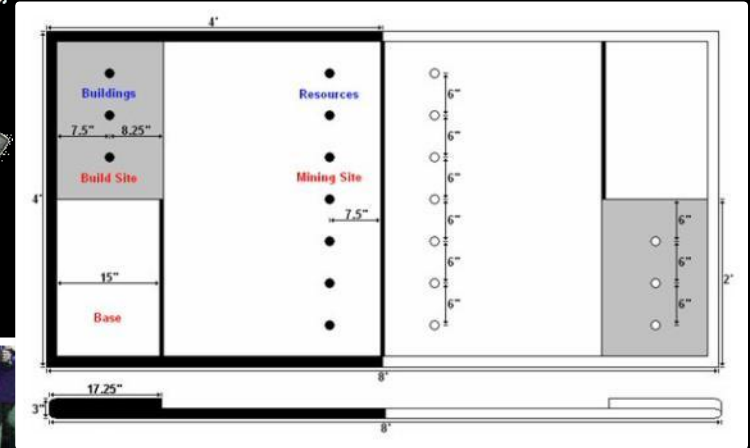
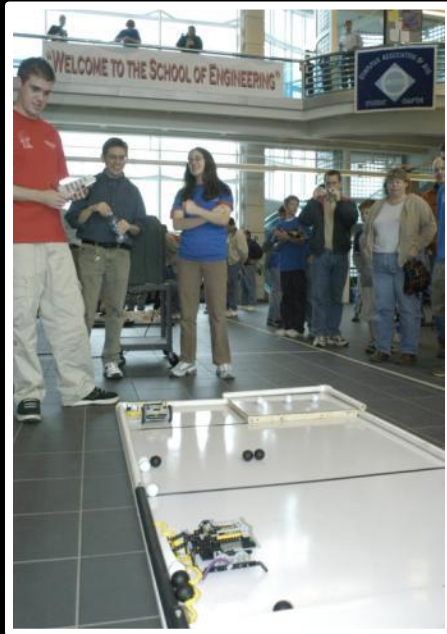

# 2005: SIUE FireBot Challenge

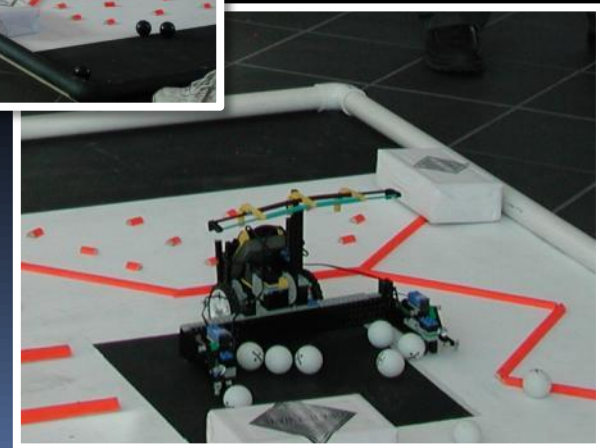
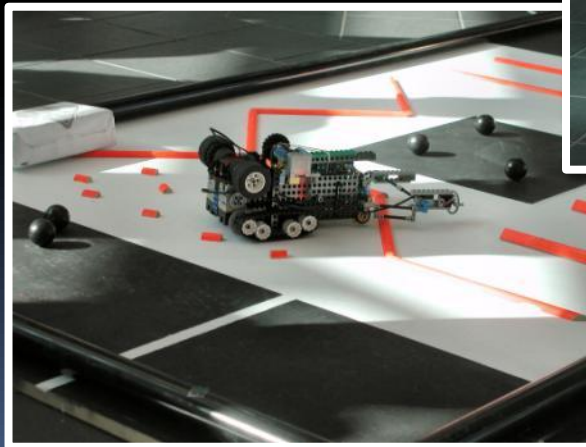
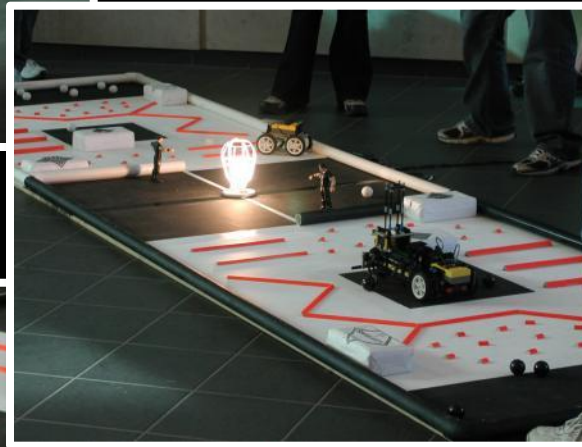
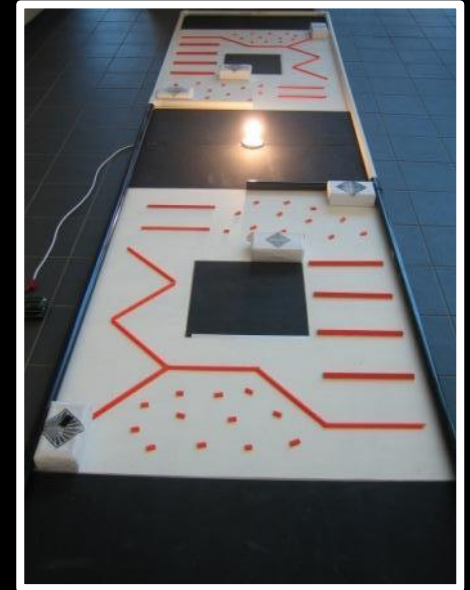
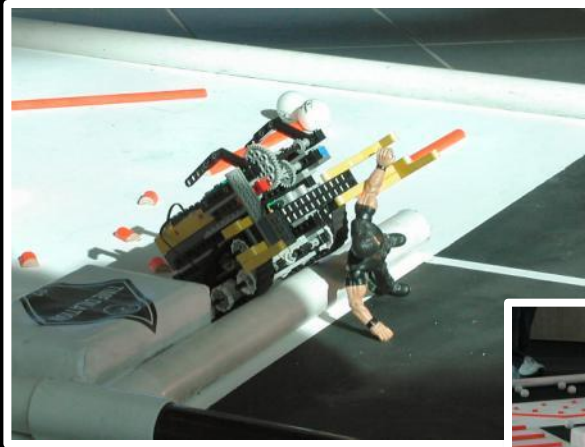

# 2006: SIUE Soccer Shootout

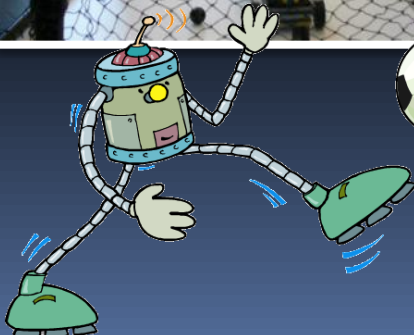
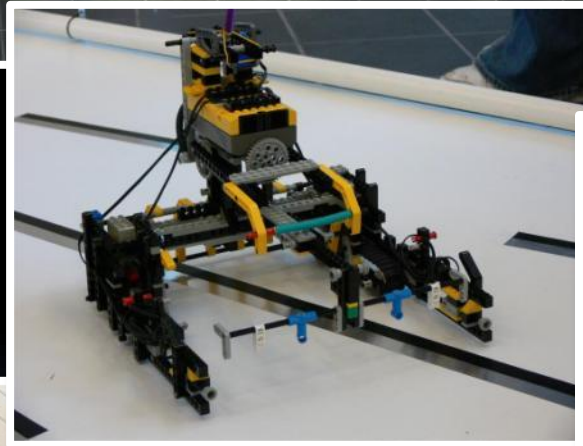
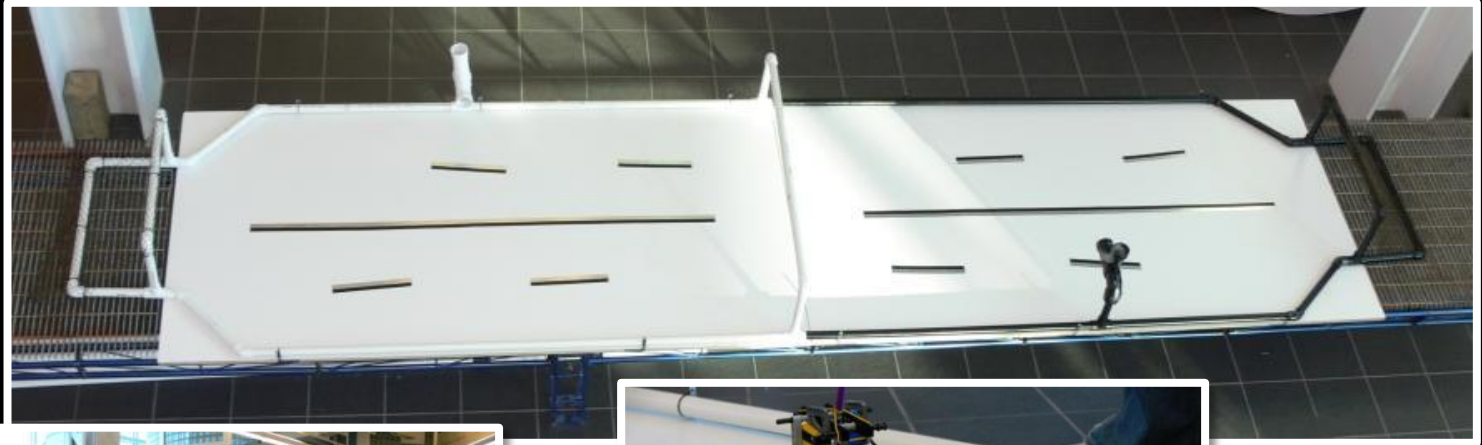

# 2005: B&G Club RoboWorkshop

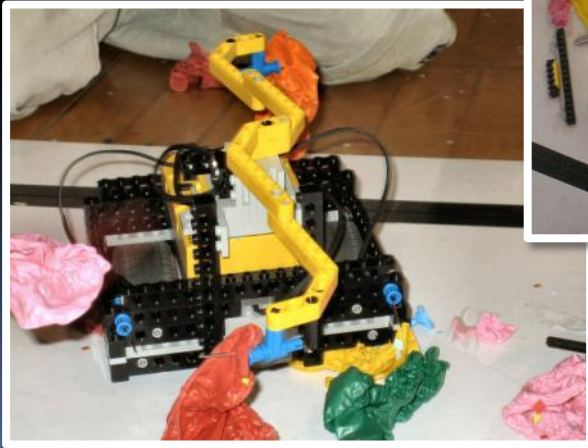
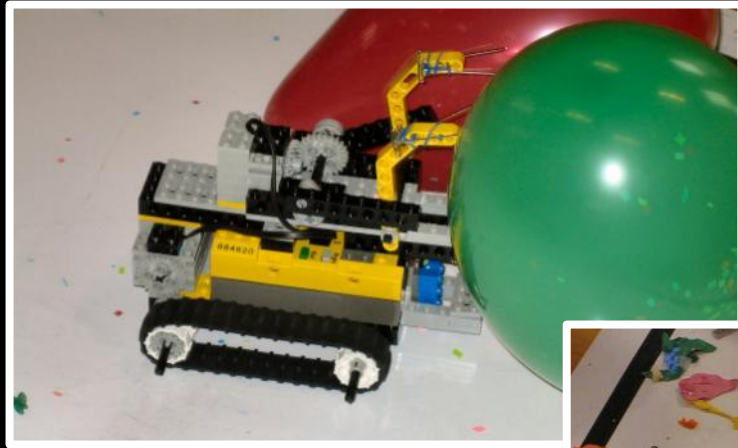

# Application

## Robotics in Education

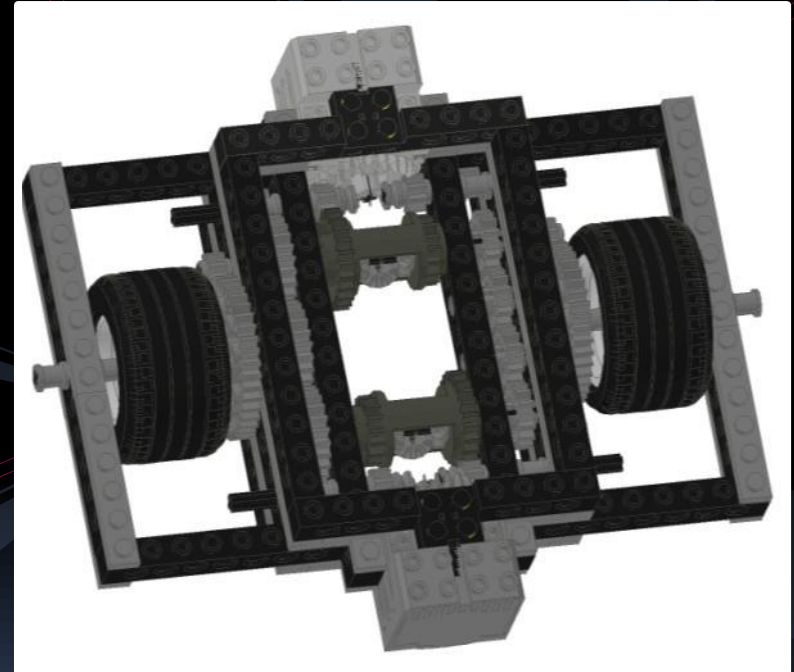
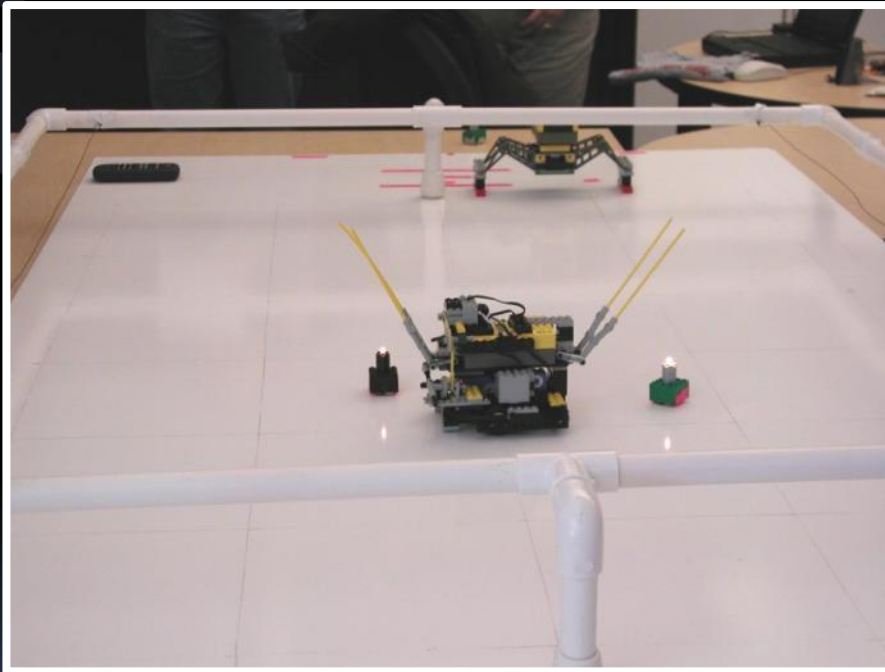

# HandyBoard (2003-2004)

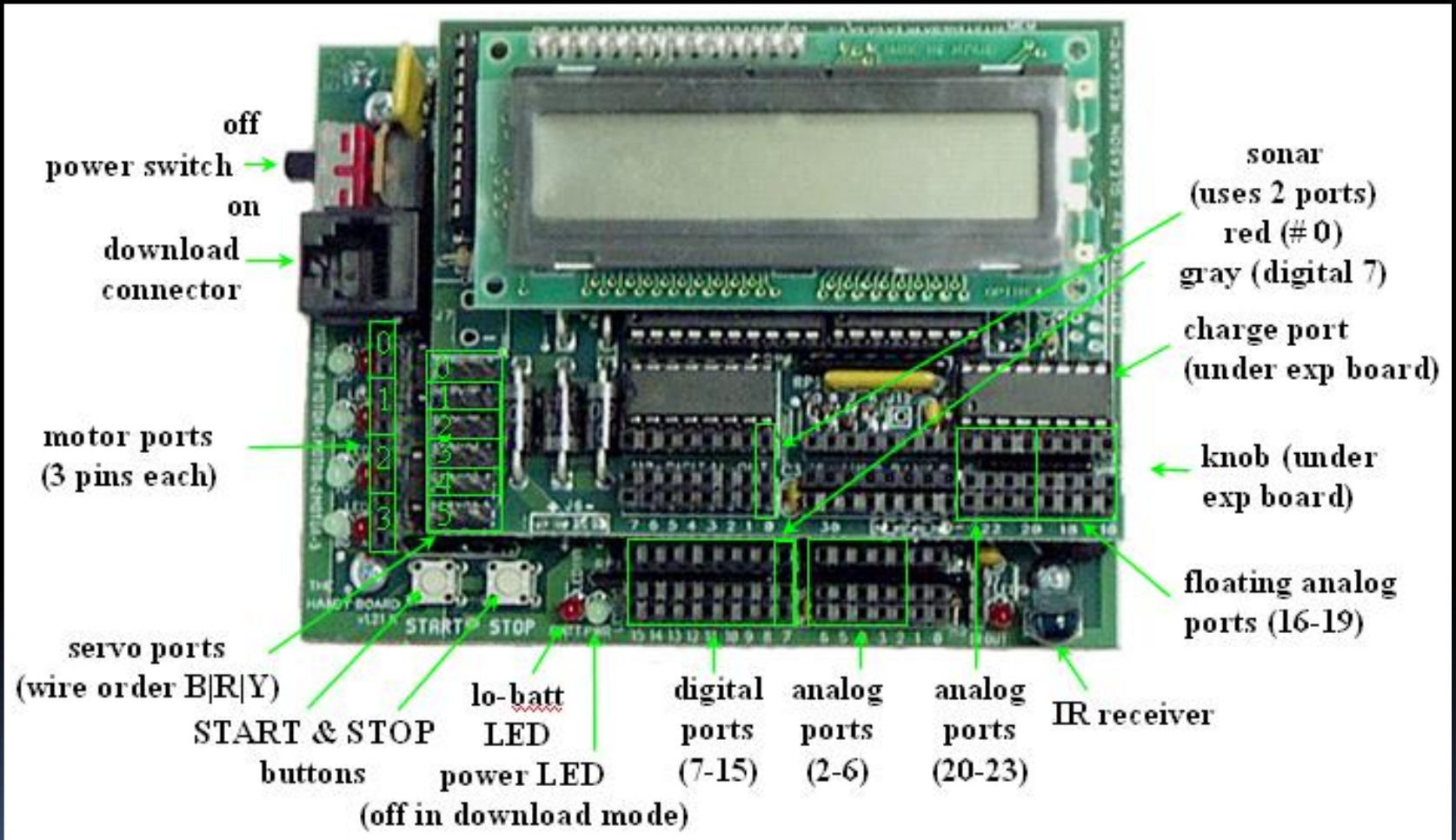



How many of you have worked with a HandyBoard?

# 2003: Botball

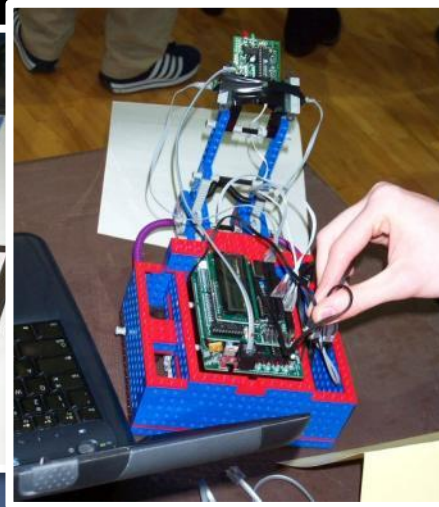
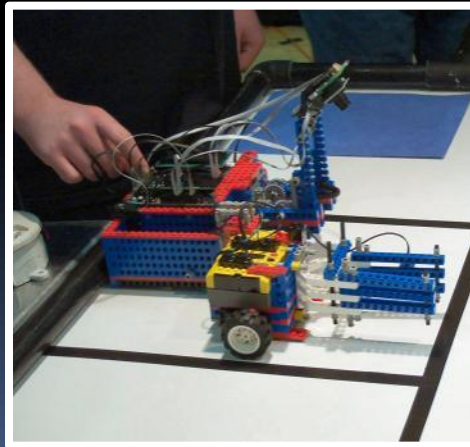
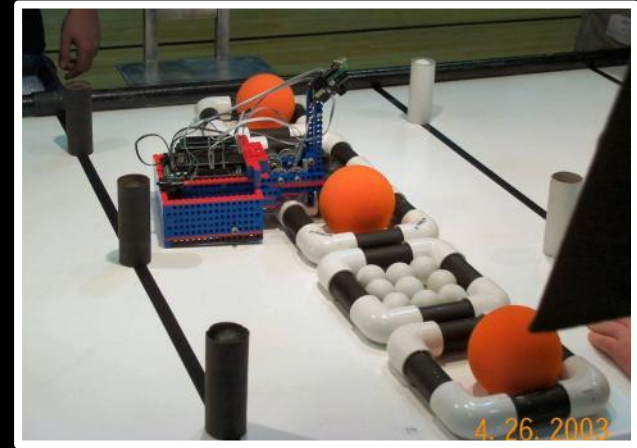



# 2004: Collegiate Botball

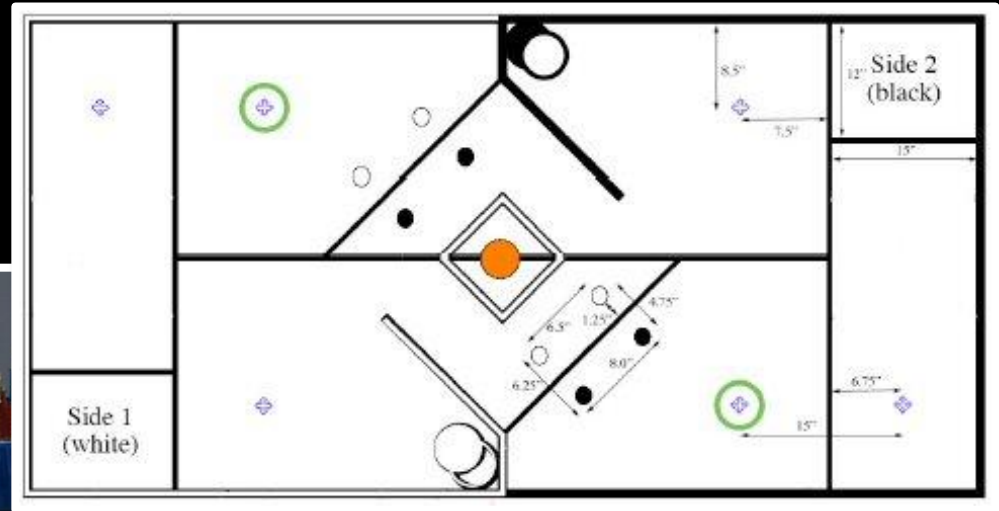
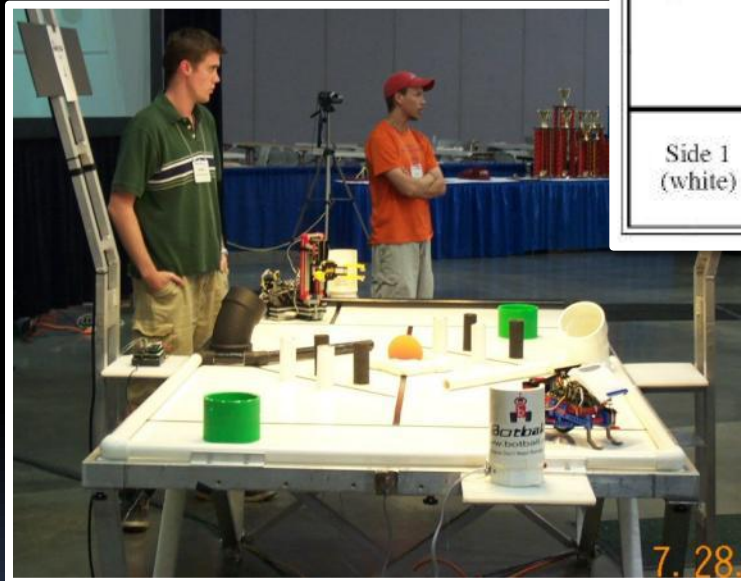

# Application

## Urban Search & Rescue

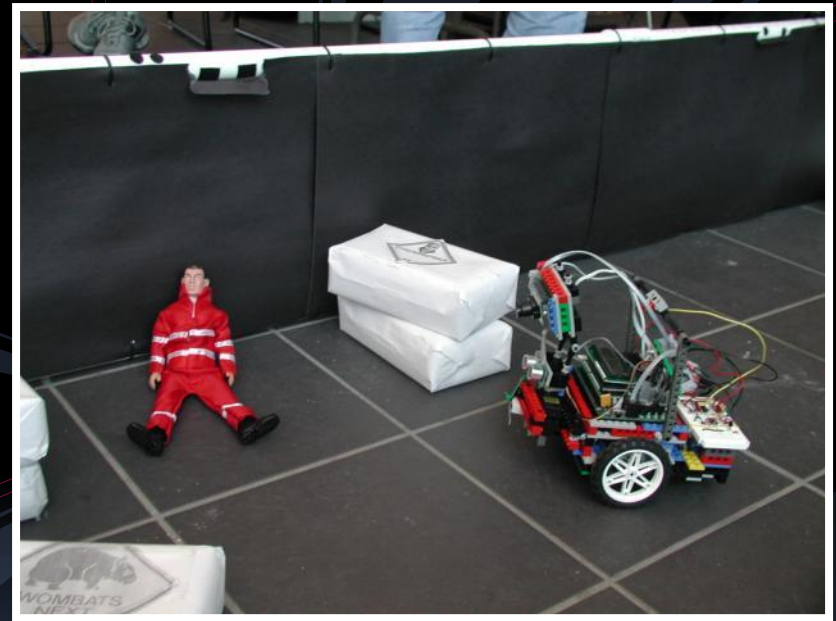
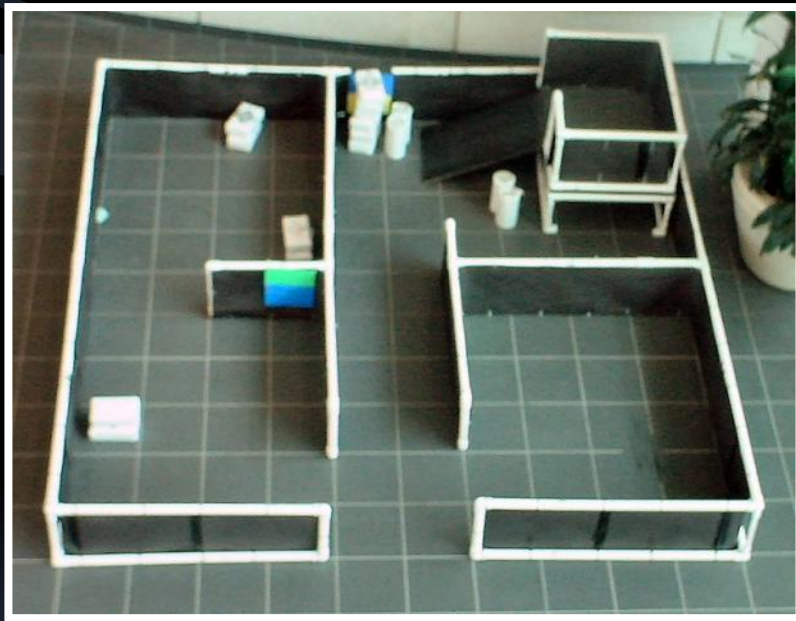

# XBC (2006-2008)

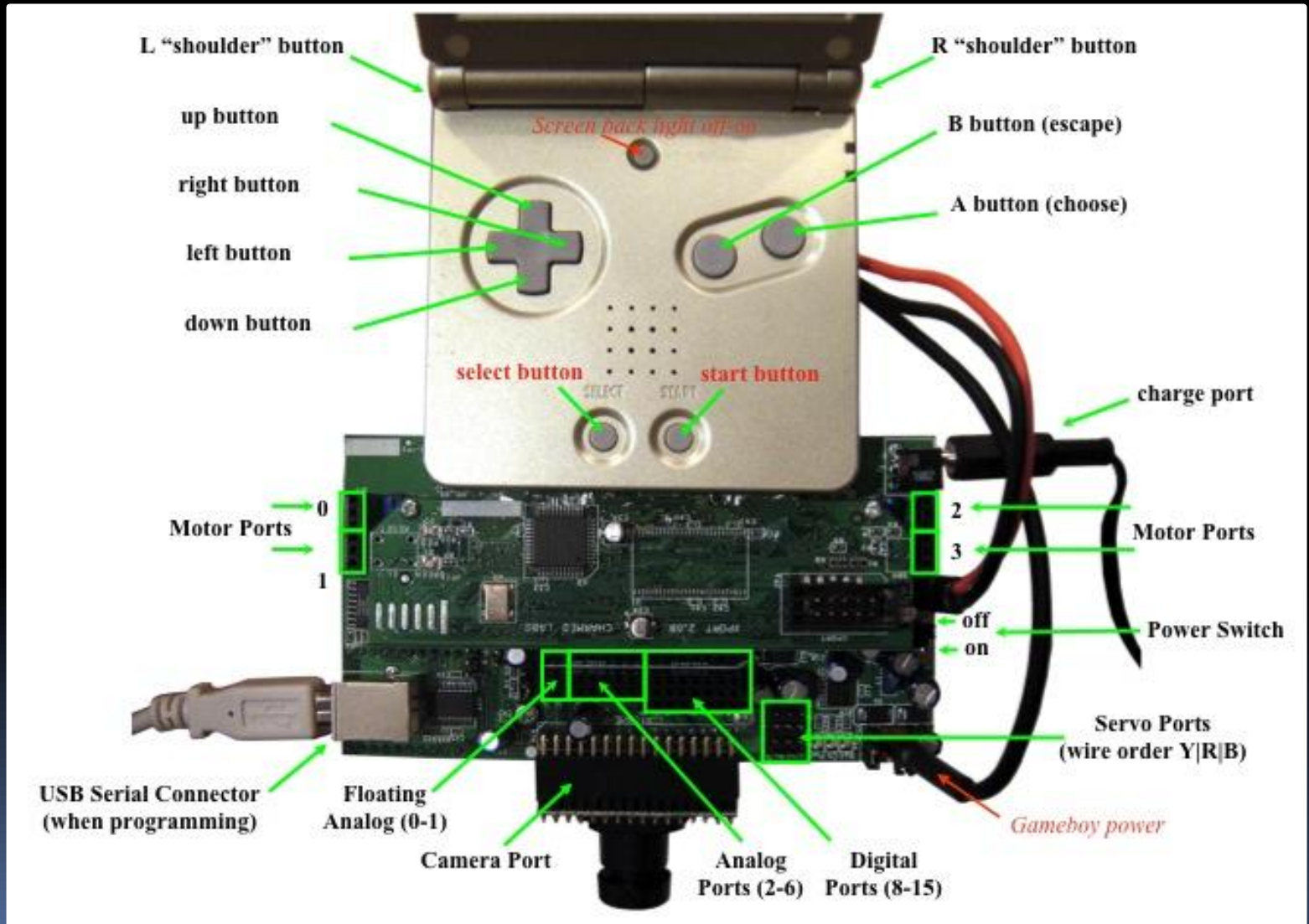



How many of you have worked with an XBC?

# 2006: Beyond Botball

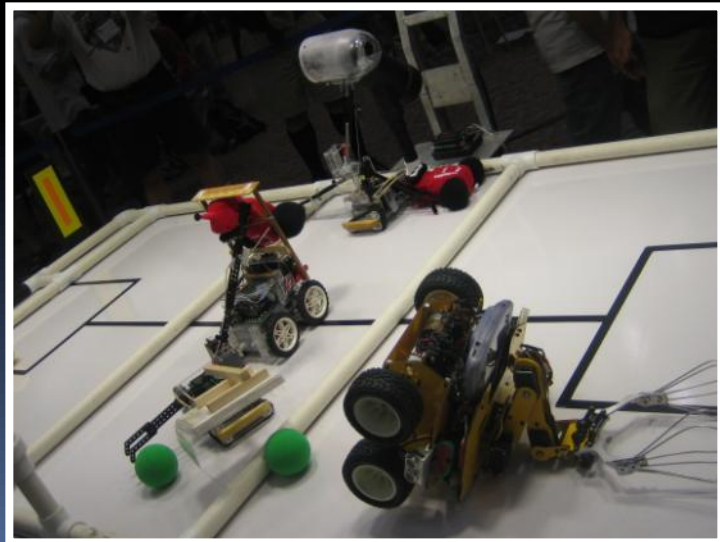
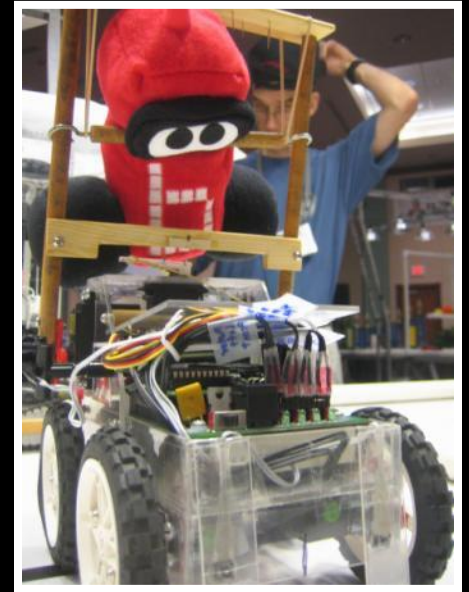
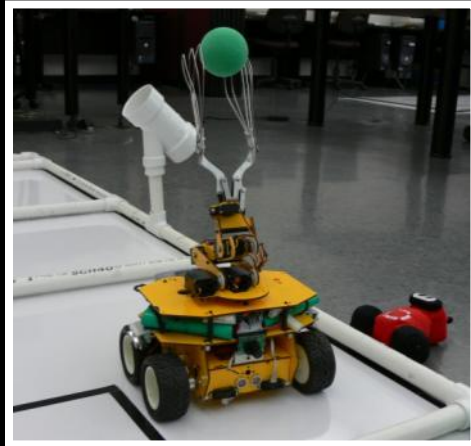

# 2007: Beyond Botball

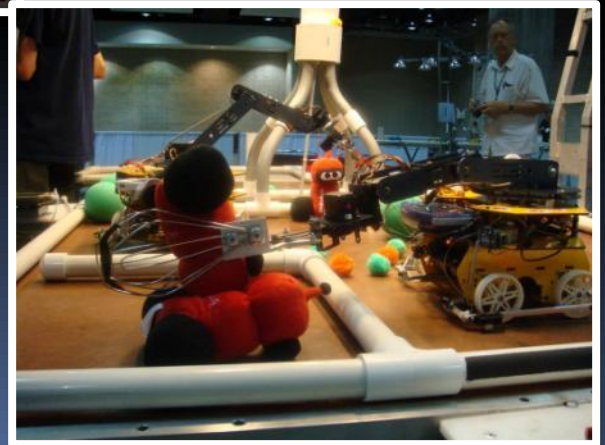
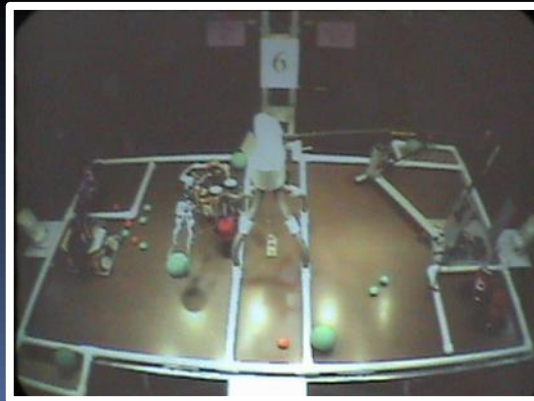
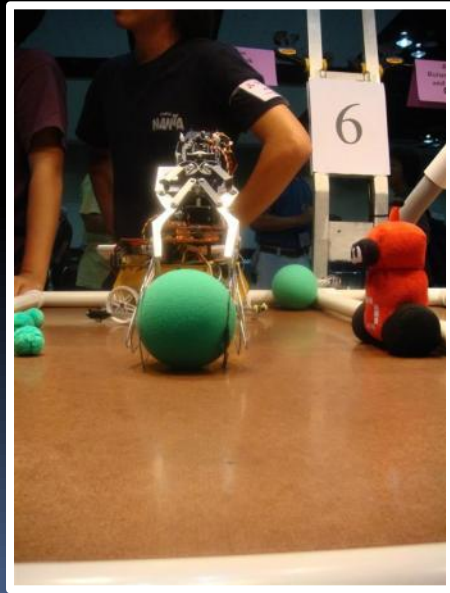
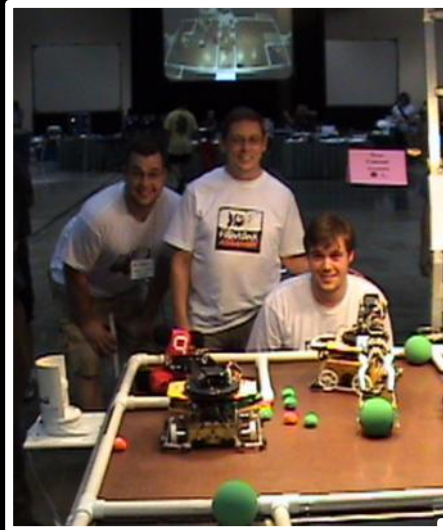



# Application

## Robot Formations

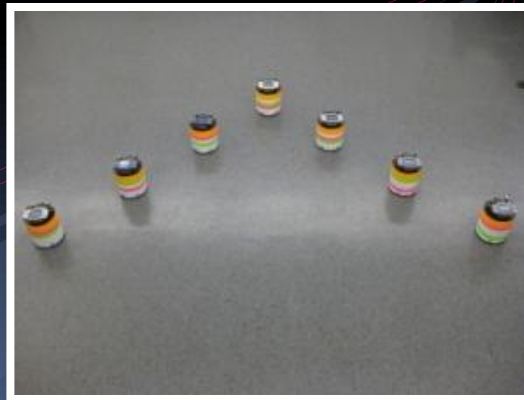
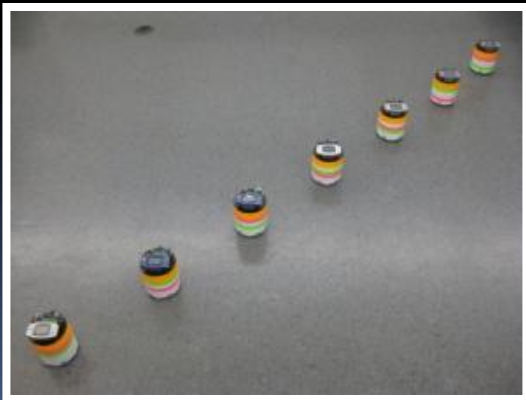
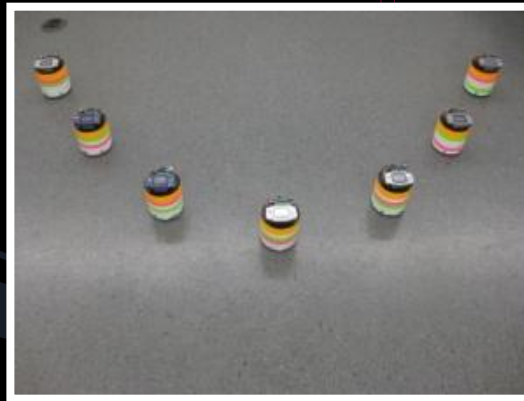
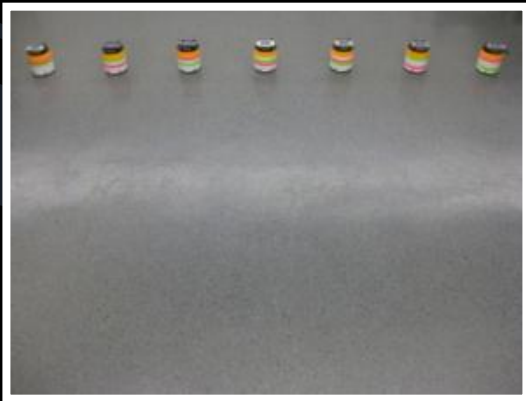

# Computation and Competition

A Decade in Review

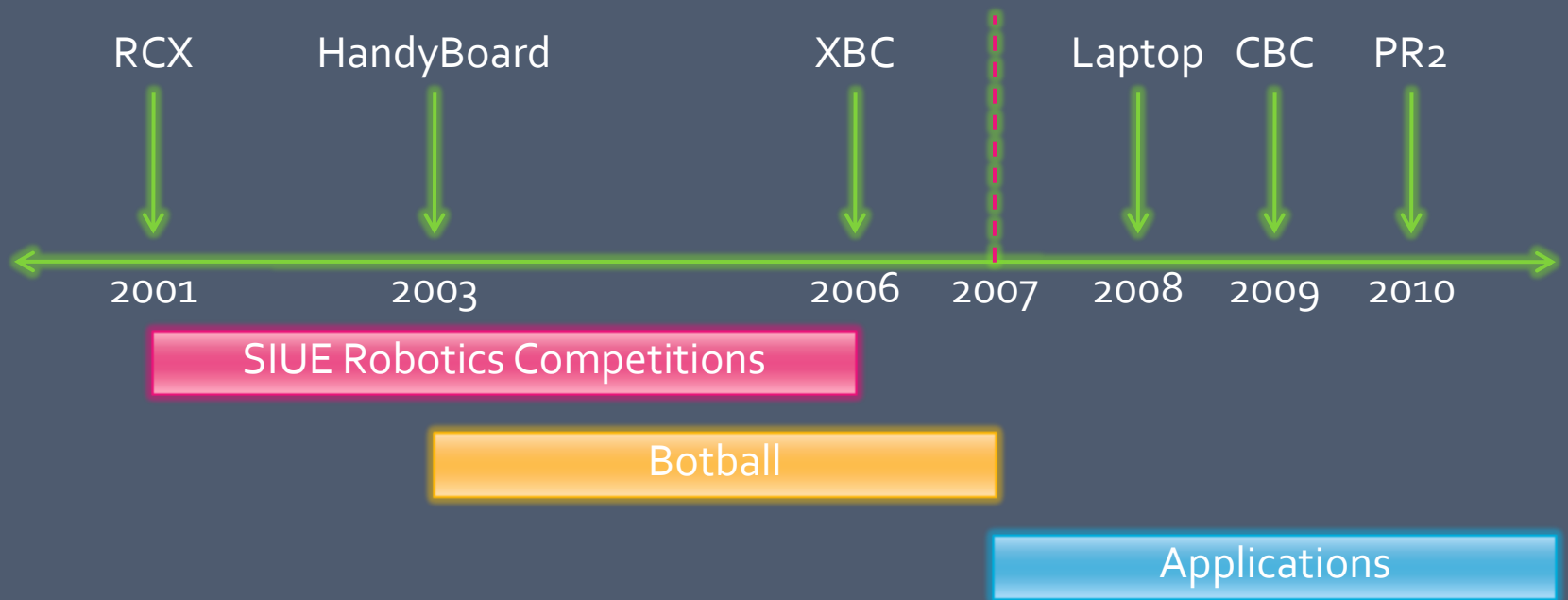
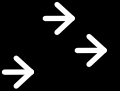



# Mini Grand Challenge

Application: Autonomous Transportation



# KIPR Open

Application: General-Purpose Robots

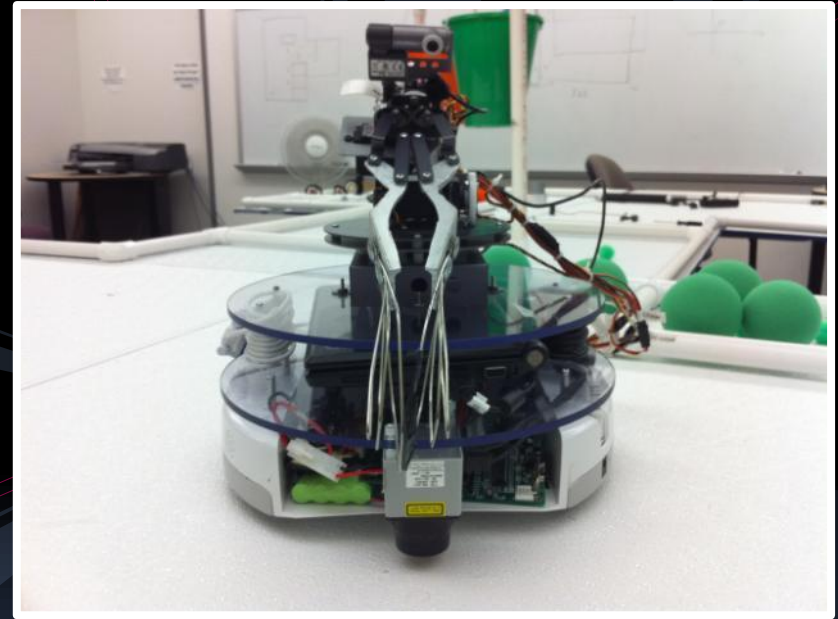
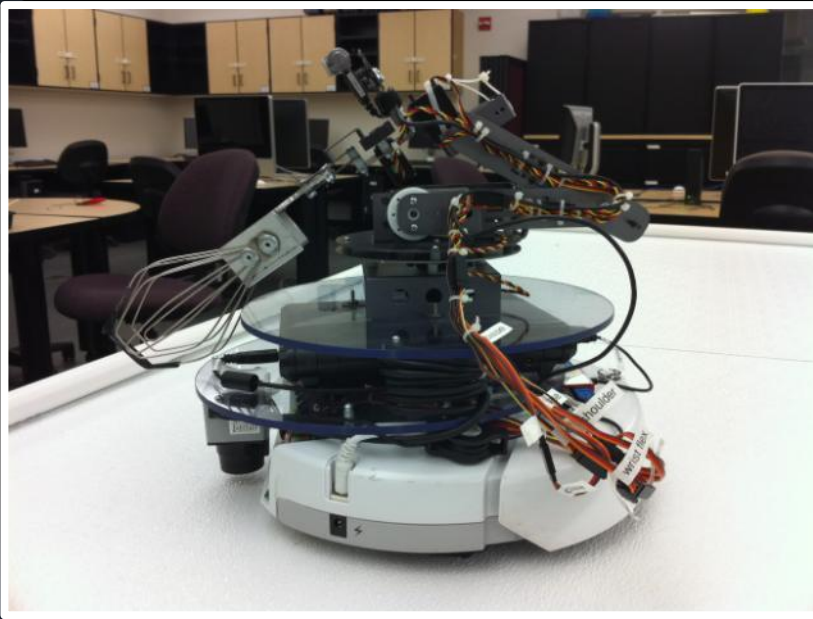



# PR2 BETA PROGRAM

# PR2

Application: Personal Robotics

- Computation
  - Two Quad-Core i7 Xeon processors (8 cores)
  - 24 GB RAM
  - 1.5 TB externally removable HD
  - 500 GB internal HD
- It has two of these!

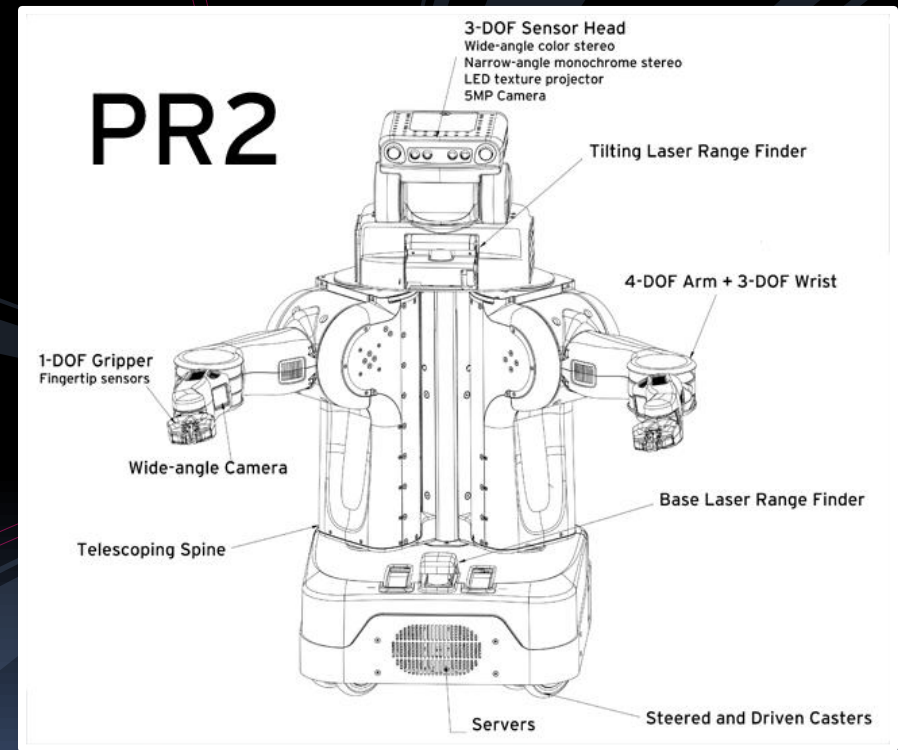



How many of you have worked with a PR2?

**HOW MANY OF YOU WANT TO?**

# PR2 Challenge?

Application: Robotics in Education

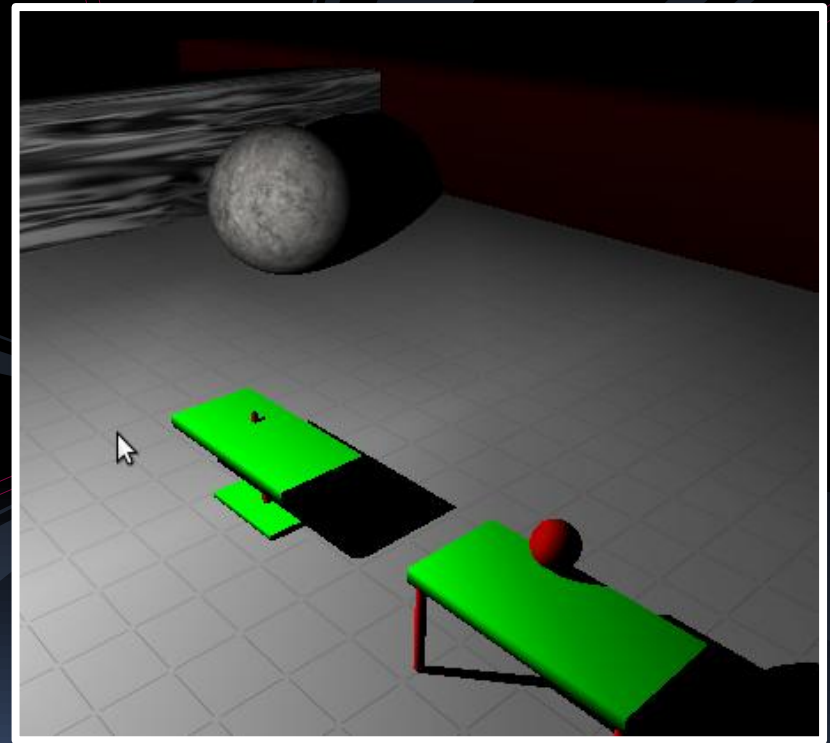
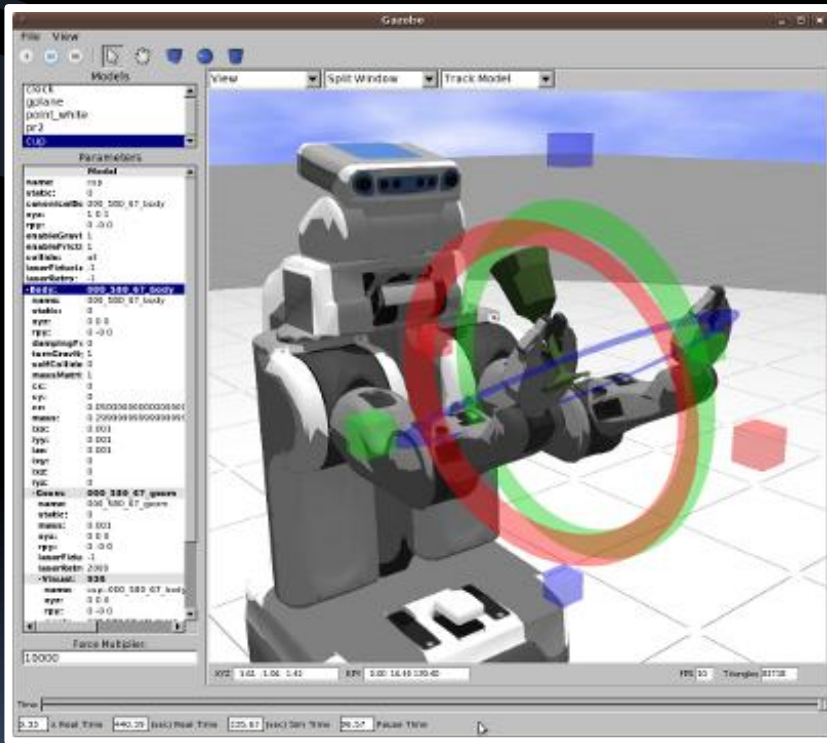



# Botball Off-Season

- Keep working!
  - Solve old challenges!
  - Create new challenges...
    - Mapping
    - Localization
    - Object Recognition
    - Obstacle Avoidance
    - Multiple Behaviors
    - Multi-Robot Coordination
    - ... and more!
- 



# EPIC FAILS



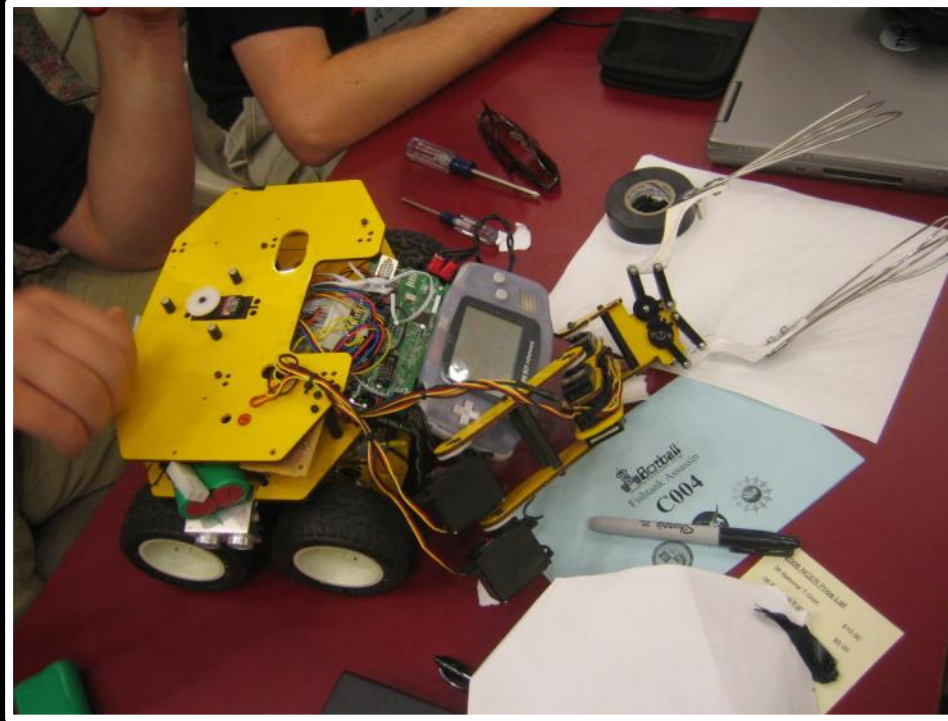

"I have not failed, I've just found 1,000\* ways that won't work."

**THOMAS EDISON**

\* Alternative numbers range from 97 to 10,000.

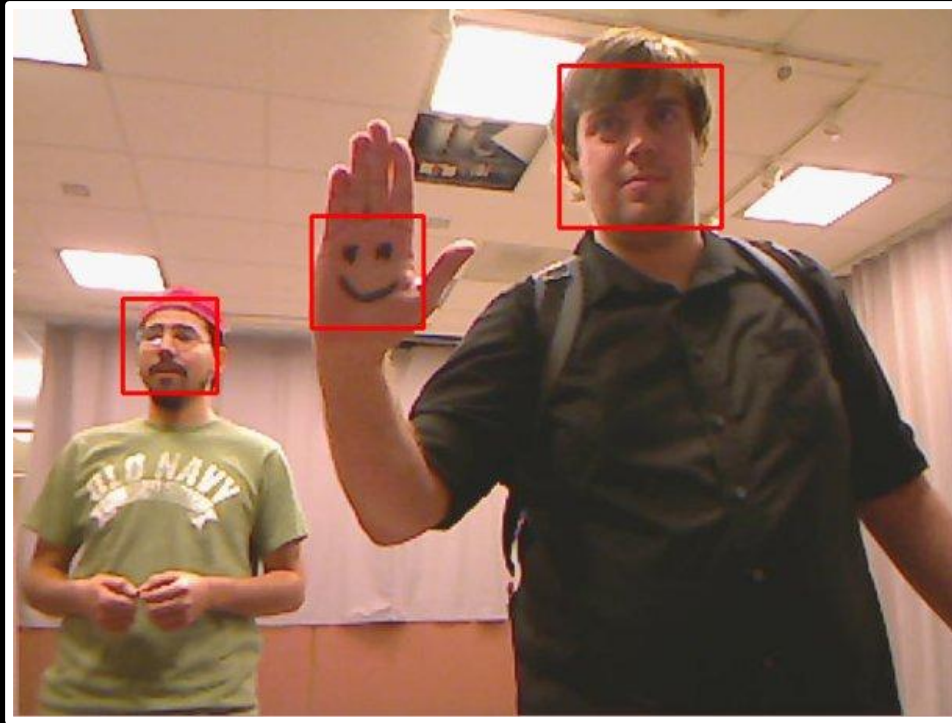

"Success is 99 percent failure."

**SOICHIRO HONDA**



Fail often.

**THANKS**